



**NordX**

**LASITUSHELAT SUIHKUUN JA SAUNAAAN**



---

# SISÄLTÖ

5	MEISTÄ
8	PINNOITTEET JA VÄRIT
9	NordX-SARANOIDEN PINTAVIIMEISTELYT
10	NordX LASIOVEN SARANAT
12	SARANAT
14	LASISEINÄN KIINNIKKEET
18	LASIOVEN VETIMET
20	LASIN TUKITANKO
26	LASITUSPROFIILIT

# NordX LASITUSHELAT SUIHKUUN JA SAUNAAAN

---

# MEISTÄ

R-FIX on ollut asiantunteva lasikiinnikkeiden valmistaja vuodesta 2010 alkaen.

Autamme arkkitehtejä ja rakennusalan ammattilaisia luomaan läpinäkyviä lasikaiteita, katoksia, julkisivuja ja muita vastuullisia lasirakenteita.

NordX-tuotesarja yhdistää turvalasituskokemuksemme nykyaikaiseen muotoiluun.

Vaikka puhdas skandinaavinen muotokieli ja miellyttävät pinnoitteet herättävätkin huomiota, NordX:n ytimenä sykkii aina ylivoimainen toiminnallisuus.

Tervetuloa NordX-maailmaan!





---

# PINNOITTEET JA VÄRIT



Harjattu musta  
Koodi: BB



Antiikkimessinki  
Koodi: AQ



Harjattu nikkeli  
Koodi: BN



Harjattu messinki  
Koodi: G



Harjattu pronssi  
Koodi: BZ

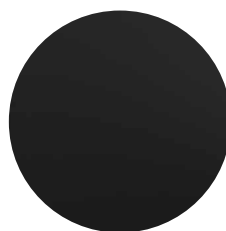

Mattamusta  
Koodi: B



Kiillotettu kromi  
Koodi: P

\* Pidätämme oikeuden lisätä tai poistaa pinnoitteita valikoimastamme kysynnän mukaan

\*\* Kaikkia pinnoitteita ei ole saatavana kaikkiin tarvikkeisiin



# NordX-SARANOIDEN PINTAVIIMEISTELYT

Onko kylpyhuoneesi tyyli luonnollinen, minimalistinen vai ylellinen? Haluatko vintage-tyylisen pronssisen korostuksen vai pidätkö enemmän klassisesta kiiltävästä kromista? NordX-mallistosta löydät laajan valikoiman erilaisia pintaviimeistelyjä



Harjattu musta



Antiikkimessinki



Harjattu nikkeli



Harjattu messinki



Harjattu pronssi

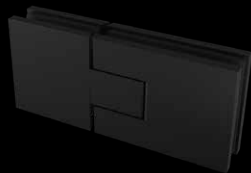

Mattamusta



Kiillotettu kromi

\* Pidätämme oikeuden lisätä tai poistaa pinnoitteita valikoimastamme kysynnän mukaan

---

# NordX LASIOVEN SARANAT

NordX-saranoissa minimalistinen muotoilu ja ammattitaitoinen suunnittelu yhdistyvät ja takaavat saumattoman kylpyhuonekokemuksen. Saranat on tarkoitettu suihkun tai saunan oviin, ja niiden mukana on saatavilla erilaisia tarvikkeita. NordX-saranat soveltuvat 6-10 mm:n karkaistulle lasille.

---

## SÄÄDETTÄVÄ NOLLA-ASENTO

Oven nolla-asentoa voidaan säätää ja lukita portaattomasti 2 mm:n kuusiokoloavaimella.



---

## PIILOKIINNITYSRUUVIT

Kun ruuvit on kiristetty ja peitellevyt painettu paikalleen miellyttävällä click-kiinnityksellä, on sarana käyttövalmis.



---

## LÄMMÖNKESTÄVÄT LASITIIVISTEET

Jotta kaikki tiivisteet soveltuisivat saunan oviin, niiden lämmönkestävyys on 150 °C.

---

## TESTATTU 100 000:SSA KÄYTTÖJAKSOSSA

NordX-saranat ovat läpäisseet syklittien pitkän käyttöiän takaamiseksi.





# SARANAT

## NordX 1

Materiaali: messinki

Kuormitettavuus: 50 kg per pari

Itsesulkeutuva 20° nolla-asennosta

Erikoisvärit ja pintaviimeistelyt ovat saatavilla pyynnöstä

Harjattu nikkeli  
Koodi: SH.NORD1.BN

Kiillotettu kromi  
Koodi: SH.NORD1.P

Harjattu messinki  
Koodi: SH.NORD1.G

Mattamusta  
Koodi: SH.NORD1.B

Harjattu musta  
Koodi: SH.NORD1.BB

Harjattu pronssi  
Koodi: SH.NORD1.BZ

Antiikkimessinki  
Koodi: SH.NORD1.AQ



## MITAT

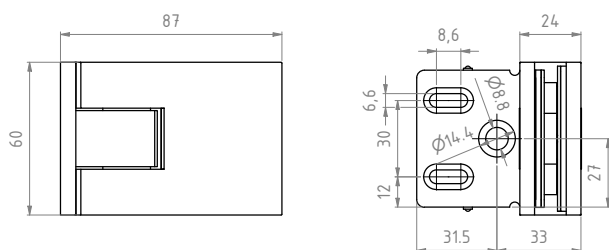

## LASIN PAKSUUS JA TIIVISTEET

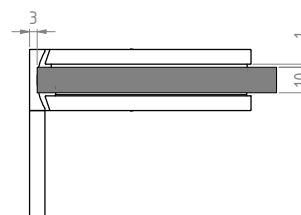
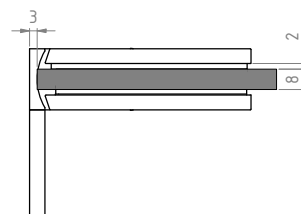
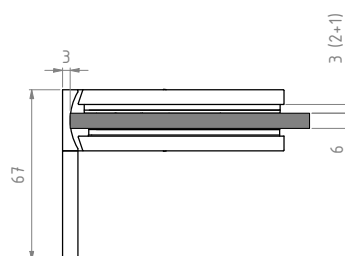

## LASIEN LEIKKAUKSET

Vällys seinästä lasiin 3 mm

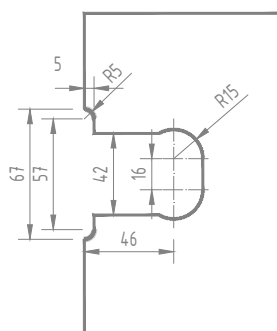

\* DWG-piirustukset ovat saatavilla pyynnöstä

## NordX 2

Materiaali: messinki  
Kuormitettavuus: 50 kg per pari  
Itsesulkeutuva 20° nolla-asennosta  
Erikoisvärit ja pintaviimeistelyt ovat saatavilla pyynnöstä

- |  |  |
|--|--|
|  Harjattu nikkeli<br>Koodi: SH.NORD2.BN |  Kiillotettu kromi<br>Koodi: SH.NORD2.P |
|  Harjattu messinki<br>Koodi: SH.NORD2.G |  Mattamusta<br>Koodi: SH.NORD2.B        |
|  Harjattu musta<br>Koodi: SH.NORD2.BB   |  Harjattu pronssi<br>Koodi: SH.NORD2.BZ |
|  Antiikkimessinki<br>Koodi: SH.NORD2.AQ |  |



### MITAT

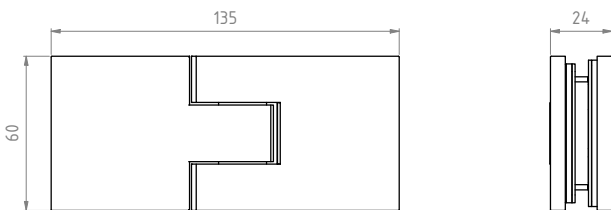

### LASIN PAKSUUS JA TIIVISTEET

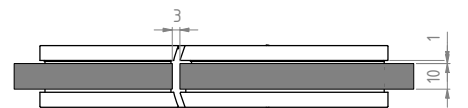
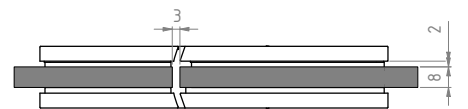
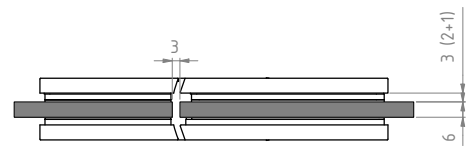

### LASIEN LEIKKAUKSET

Vällys lasista lasiin 3 mm

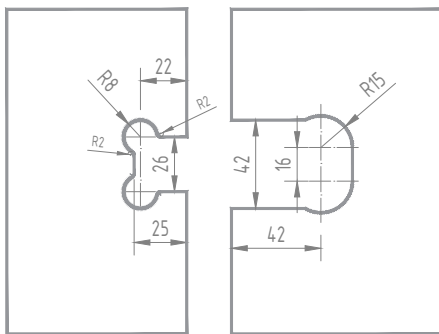

\* DWG-piirustukset ovat saatavilla pyynnöstä

# LASISEINÄN KIINNIKKEET





## SEINÄSTÄ LASIIN -KIINNIKE

Piilokiinnitysruuvit

Lämmönkestävät lasitiivisteet

Vaatii  $\varnothing 14$  mm työstön lasiin

Erikoisvärit ja pintaviimeistelyt ovat saatavilla pyynnöstä

- |   |   |
|---|---|
|  Harjattu nikkeli<br>Koodi: SH.C1.BN |  Kiillotettu kromi<br>Koodi: SH.C1.P |
|  Harjattu messinki<br>Koodi: SH.C1.G |  Mattamusta<br>Koodi: SH.C1.B        |
|  Harjattu musta<br>Koodi: SH.C1.BB   |  Harjattu pronssi<br>Koodi: SH.C1.BZ |
|  Antiikkimessinki<br>Koodi: SH.C1.AQ |   |



### MITAT

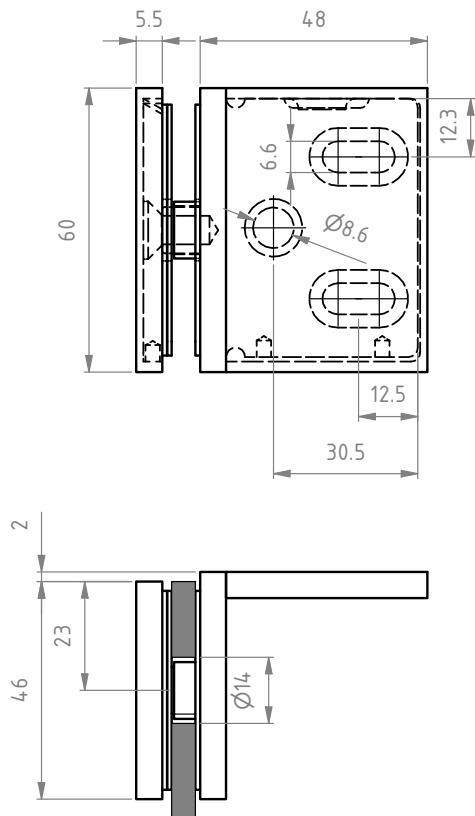

### LASIN PAKSUUS JA TIIVISTEET

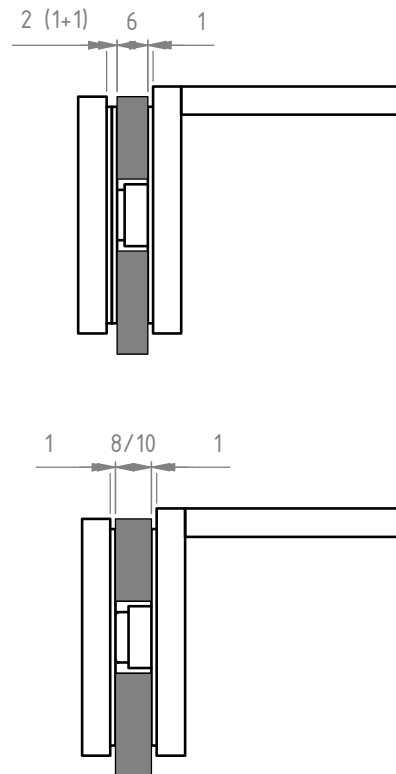

\* DWG-piirustukset ovat saatavilla pyynnöstä

## LASISTA LASIIN -KIINNIKE 180°

Piilokiinnitysruuvit

Lämmönkestävät lasitiivisteet

Vaatii  $\varnothing 14$  mm työstön lasiin

Erikoisvärit ja pintaviimeistelyt ovat saatavilla  
pyynnöstä



Harjattu nikkeli  
Koodi: SH.C2.BN



Kiillotettu kromi  
Koodi: SH.C2.P



Harjattu messinki  
Koodi: SH.C2.G



Mattamusta  
Koodi: SH.C2.B



Harjattu musta  
Koodi: SH.C2.BB



Harjattu pronssi  
Koodi: SH.C2.BZ



Antiikkimessinki  
Koodi: SH.C2.AQ



### MITAT

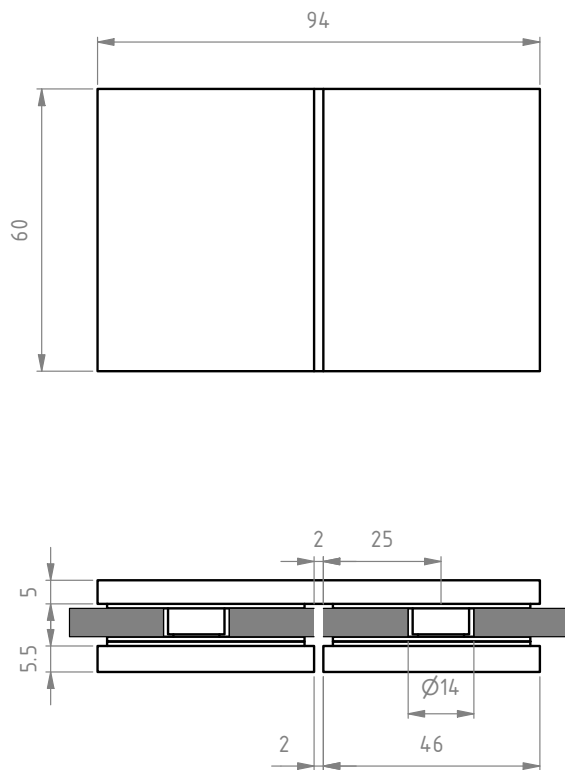

### LASIN PAKSUUS JA TIIVISTEET

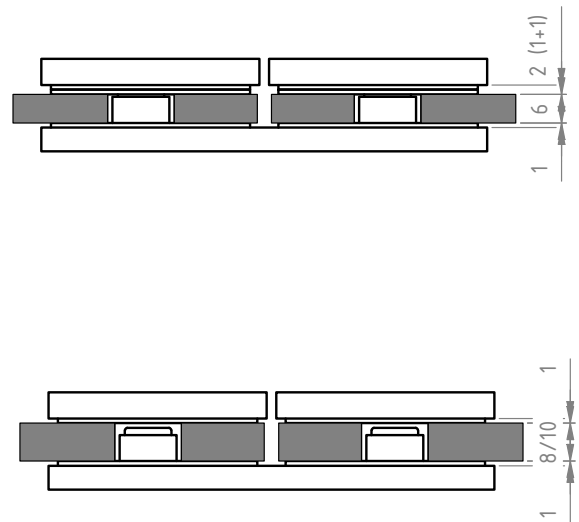

\* DWG-piirustukset ovat saatavilla pyynnöstä

# LASISEINÄN KIINNIKKEET

## LASISTA LASIIN -KIINNIKE 90°

Piilokiinnitysruuvit

Lämmönkestävät lasitiivisteet

Vaatii  $\varnothing 14$  mm työstön lasiin

Erikoisvärit ja pintaviimeistelyt ovat saatavilla pyynnöstä

- |   |   |
|---|---|
|  Harjattu nikkeli<br>Koodi: SH.C3.BN |  Kiillotettu kromi<br>Koodi: SH.C3.P |
|  Harjattu messinki<br>Koodi: SH.C3.G |  Mattamusta<br>Koodi: SH.C3.B        |
|  Harjattu musta<br>Koodi: SH.C3.BB   |  Harjattu pronssi<br>Koodi: SH.C3.BZ |
|  Antiikkimessinki<br>Koodi: SH.C3.AQ |   |



### MITAT

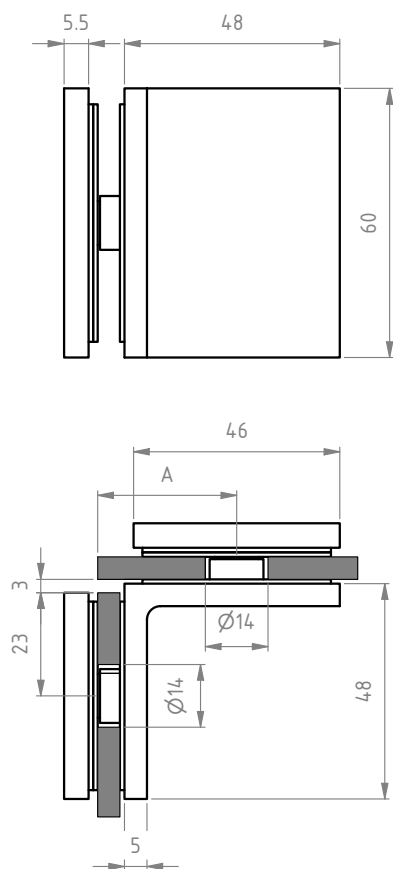

\* DWG-piirustukset ovat saatavilla pyynnöstä

### LASIN PAKSUUS JA TIIVISTEET

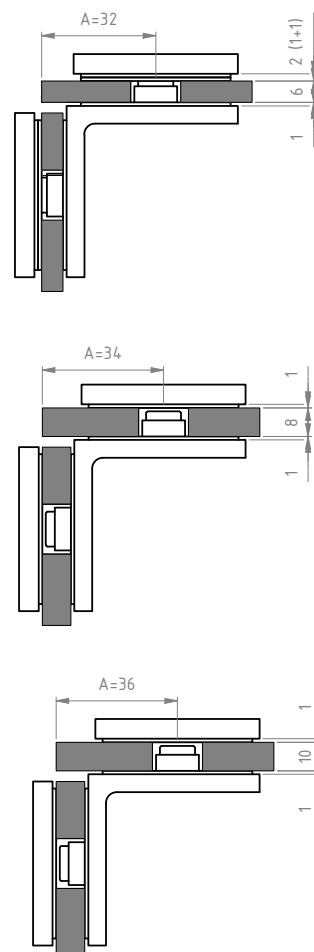









# LASIOVEN VETIMET

## PYÖREÄ SUIHKUOVEN VEDIN



- |   |   |
|---|---|
|  Harjattu nikkeli<br>Koodi: SH.K1.BN |  Kiillotettu kromi<br>Koodi: SH.K1.P |
|  Harjattu messinki<br>Koodi: SH.K1.G |  Harjattu musta<br>Koodi: SH.K1.BB   |
|  Harjattu pronssi<br>Koodi: SH.K1.BZ |  Antiikkimessinki<br>Koodi: SH.K1.AQ |

## PYÖREÄ SAUNAN-/ SUIHKUOVEN VEDIN



- |  |  |
|--|--|
|  Harjattu nikkeli<br>Koodi: SH.K1W.BN |  Kiillotettu kromi<br>Koodi: SH.K1W.P |
|  Harjattu messinki<br>Koodi: SH.K1W.G |  Harjattu musta<br>Koodi: SH.K1W.BB   |
|  Harjattu pronssi<br>Koodi: SH.K1W.BZ |  Antiikkimessinki<br>Koodi: SH.K1W.AQ |

### MITAT

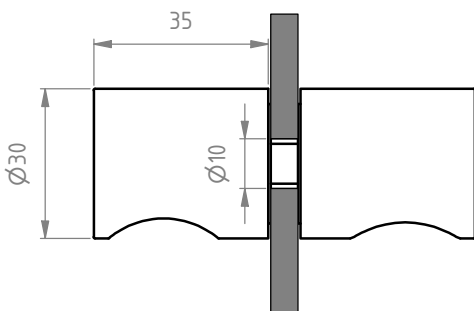



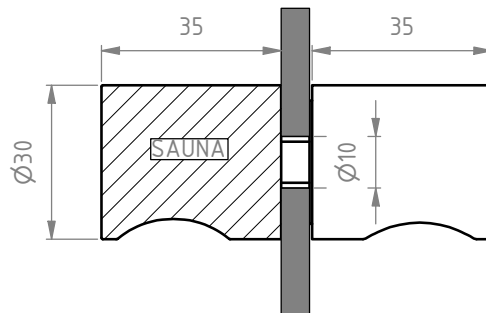



### MITAT



\* Materiaali: messinki. Saunan puoleinen vedin on tehty puusta ja se tulisi viimeistellä ennen käyttöä.







## SUORAKULMAINEN SUIHKUOVEN VEDIN



- |   |   |
|---|---|
|  Harjattu nikkeli<br>Koodi: SH.K2.BN |  Kiillotettu kromi<br>Koodi: SH.K2.P |
|  Harjattu messinki<br>Koodi: SH.K2.G |  Harjattu musta<br>Koodi: SH.K2.BB   |
|  Harjattu pronssi<br>Koodi: SH.K2.BZ |  Antiikkimessinki<br>Koodi: SH.K2.AQ |

## SUORAKULMAINEN SAUNAN-/SUIHKUOVEN VEDIN



- |  |  |
|--|--|
|  Harjattu nikkeli<br>SH.K2W.BN        |  Kiillotettu kromi<br>Koodi: SH.K2W.P |
|  Harjattu messinki<br>Koodi: SH.K2W.G |  Harjattu musta<br>Koodi: SH.K2W.BB   |
|  Harjattu pronssi<br>Koodi: SH.K2W.BZ |  Antiikkimessinki<br>Koodi: SH.K2W.AQ |

### MITAT

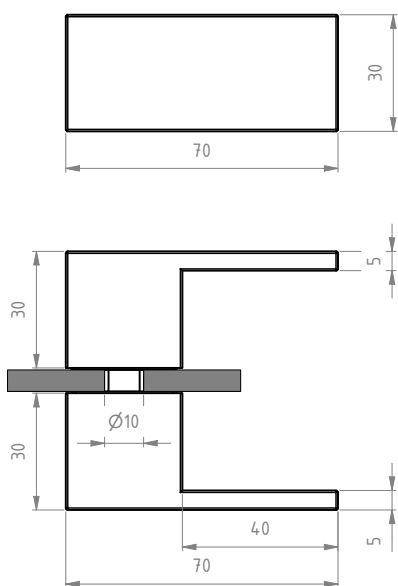

### MITAT

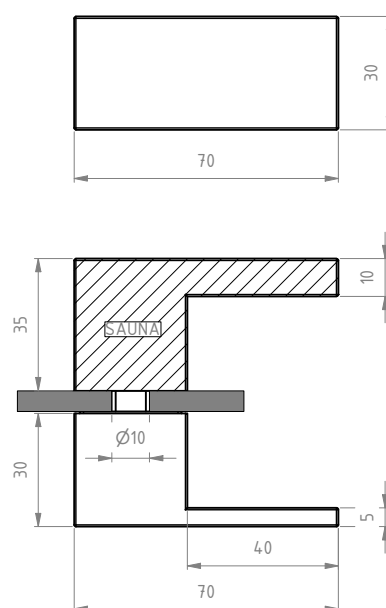

\* Materiaali: messinki. Saunan puoleinen vedin on tehty puusta ja se tulisi viimeistellä ennen käyttöä.

---

# LASIN TUKITANKO

Tukitanko on hyvä ratkaisu lasin jäykistämiseen sen yläreunasta. Modulaarisuuden ansiosta on mahdollista tukea useita erilaisia suihkuseiniä valitsemalla oikeat komponentit.

## KLASSINEN NURKKAUS



## JATKETTU NURKKAUS



## SUIHKUKAAPPI



---

**KLASSINEN  
SUIHKUSYVENNYS**



**JATKETTU  
SUIHKUSYVENNYS**



**WALK-IN**



# LASIN TUKITANKO

## LASILIIITIN, SÄÄDETTÄVÄ KULMA



- |  |  |
|--|--|
|  Harjattu nikkeli<br>Koodi: SH.TC1.BN  |  Kiillotettu kromi<br>Koodi: SH.TC1.P  |
|  Harjattu messinki<br>Koodi: SH.TC1.G |  Harjattu musta<br>Koodi: SH.TC1.BB   |
|  Harjattu pronssi<br>Koodi: SH.TC1.BZ |  Antiikkimessinki<br>Koodi: SH.TC1.AQ |

## SEINÄLIIITIN, SÄÄDETTÄVÄ KULMA



- |  |  |
|--|--|
|  Harjattu nikkeli<br>Koodi: SH.TC2.BN  |  Kiillotettu kromi<br>Koodi: SH.TC2.P  |
|  Harjattu messinki<br>Koodi: SH.TC2.G |  Harjattu musta<br>Koodi: SH.TC2.BB   |
|  Harjattu pronssi<br>Koodi: SH.TC2.BZ |  Antiikkimessinki<br>Koodi: SH.TC2.AQ |

### MITAT

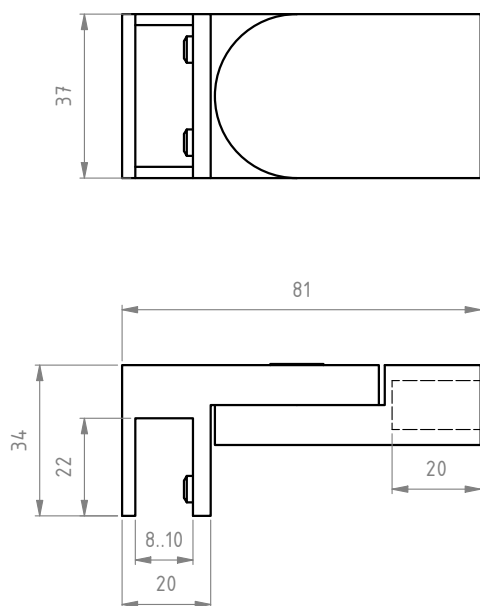

### MITAT

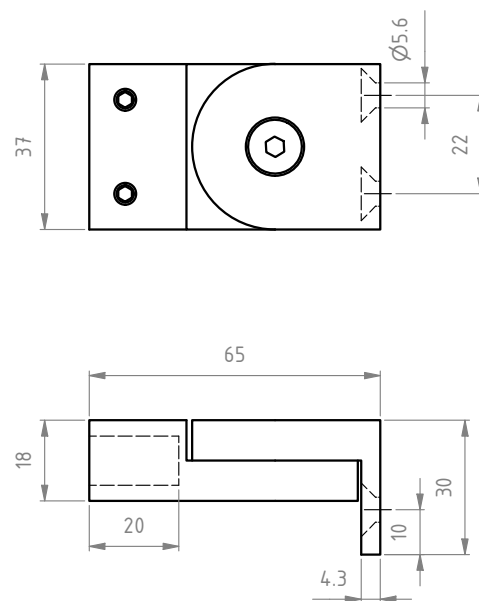

## SEINÄLIITIN



● Harjattu nikkeli  
Koodi: SH.TC3.BN

● Harjattu messinki  
Koodi: SH.TC3.G

● Harjattu pronssi  
Koodi: SH.TC3.BZ

● Kiillotettu kromi  
Koodi: SH.TC3.P

● Harjattu musta  
Koodi: SH.TC3.BB

● Antiikkimessinki  
Koodi: SH.TC3.AQ

## T-LIITIN



● Harjattu nikkeli  
Koodi: SH.TC4.BN

● Harjattu messinki  
Koodi: SH.TC4.G

● Harjattu pronssi  
Koodi: SH.TC4.BZ

● Kiillotettu kromi  
Koodi: SH.TC4.P

● Harjattu musta  
Koodi: SH.TC4.BB

● Antiikkimessinki  
Koodi: SH.TC4.AQ

### MITAT

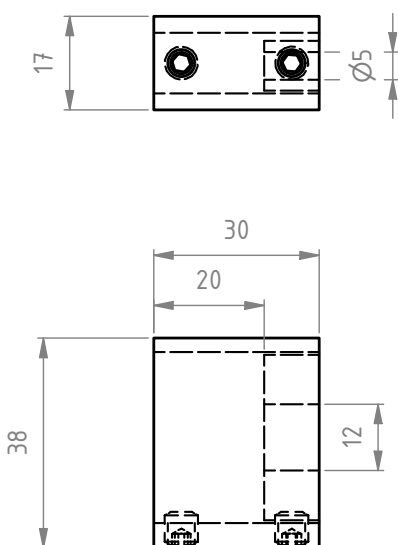

### MITAT

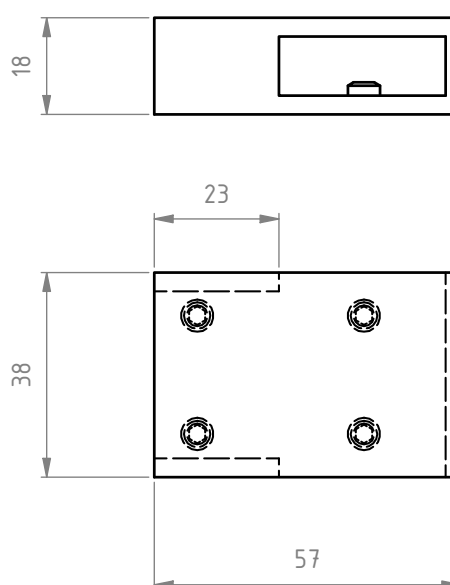

# LASIN TUKITANKO

**PUTKI 10 X 30,  
PITUUS 1 M**



● Harjattu nikkeli  
Koodi: SH.Tx1M.BN

● Harjattu messinki  
Koodi: SH.Tx1M.G

● Harjattu pronssi  
Koodi: SH.Tx1M.BZ

● Kiillotettu kromi  
Koodi: SH.Tx1M.P

● Harjattu musta  
Koodi: SH.Tx1M.BB

● Antiikkimessinki  
Koodi: SH.Tx1M.AQ

**PUTKI 10 X 30,  
PITUUS 2 M**



● Harjattu nikkeli  
Koodi: SH.Tx2M.BN

● Harjattu messinki  
Koodi: SH.Tx2M.G

● Harjattu pronssi  
Koodi: SH.Tx2M.BZ

● Kiillotettu kromi  
Koodi: SH.Tx2M.P

● Harjattu musta  
Koodi: SH.Tx2M.BB

● Antiikkimessinki  
Koodi: SH.Tx2M.AQ

**MITAT**

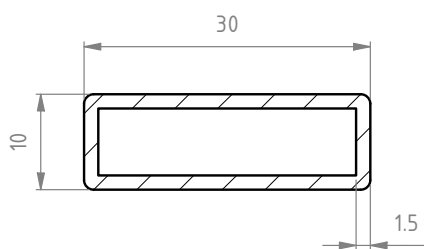

**MITAT**

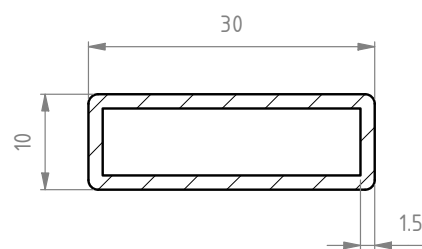





# LASITUSPROFIILIT

## MATALA U-PROFIILI



- Harjattu nikkeli-efekti anodisointi  
Koodi 8mm:n lasille : GU8L.SS  
Koodi 10mm:n lasille: GU10L.SS
- Sähkökiillotettu anodisointi  
Koodi 8mm:n lasille: GU8L.P  
Koodi 10mm:n lasille: GU10L.P
- Mattamusta anodisointi  
Koodi 8mm:n lasille: GU8L.B  
Koodi 10mm:n lasille: GU10L.B

## KORKEA U-PROFIILI



- Harjattu nikkeli-efekti anodisointi  
Koodi 8mm:n lasille: GU8H.SS  
Koodi 10mm:n lasille: GU10H.SS
- Sähkökiillotettu anodisointi  
Koodi 8mm:n lasille: GU8H.P  
Koodi 10mm:n lasille: GU10H.P
- Mattamusta anodisointi  
Koodi 8mm:n lasille: GU8H.B  
Koodi 10mm:n lasille: GU10H.B

### MITAT

8mm:n lasille

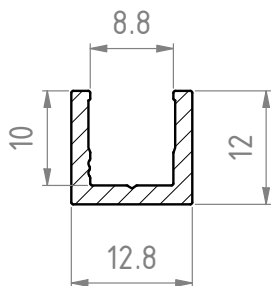

10mm:n lasille

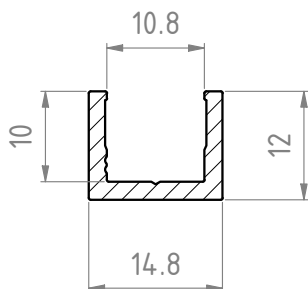

### MITAT

8mm:n lasille

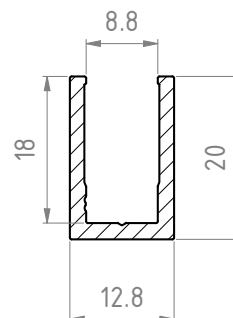

10mm:n lasille

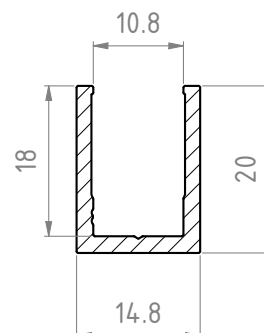

\* Materiaali: anodisoitu alumiini



**R·FIX**  
LASINKIINNIKKEIDEN VALMISTAJA

Kurna tee 14, Kiili 75401,  
Harjumaa, Viro  
info@rfix.eu  
rfix.eu