



NordX
SAUNA- JA DUŠISARI

SISUKORD

5	ETTEVÖTTEST
8	PINNAKATTED JA VÄRVITOONID
9	NordX HINGEDE PINNAVIIMISTLUSED
10	NordX DUŠIHINGED
12	HINGED
14	DUŠISEINA KLAMBRID
18	KLAASUKSE NUPUD
20	KLAASI TUGILATT
26	KLAASIMISPROFIILID

NordX SAUNA- JA DUŠISARI

ETTEVÖTTEST

R-FIX on 2010. aastal asutatud arhitektuursete klaasikinnituste tootja.

Aitame arhitektidel ja ehitajatel luua turvalisi klaasipirdeid, -varikatuseid, -fassaade ja muid vastutusrikkaid klaaskonstruksioone.

NordX sauna- ja dušitoodete sarjaga oleme ühendanud oma turvaliste klaasikinnituste tootmise kogemuse ajatu disainiga.

Kuigi puhtad vormid ja kaunid pinnakatted on pilkupüüdvad, on NordX toodete südameks siiski läbimõeldud funktsionaalsus.

Tere tulemast NordXi maailma!





PINNAKATTED JA VÄRVITOONID



Harjatud must
Kood: BB



Antiikmessing
Kood: AQ



Harjatud nikkel
Kood: BN



Harjatud messing
Kood: G



Harjatud pronks
Kood: BZ

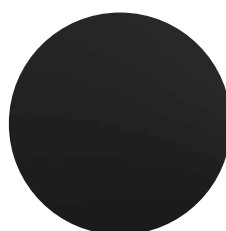

Matt must
Kood: B



Poleeritud kroom
Kood: P

* Jätame endale õiguse lisada või eemaldada pinnakatteid tootevalikust

** Kõik pinnakatted ei ole kõikide tarvikute jaoks saadaval

NordX HINGEDE PINNAVIIMISTLUSED

Kas teie vannituba on kujundatud naturaalses, minimalistlikus või luksuslikus stiilis? Kas otsite retrohõngulist pronksjat aktsenti või eelistate klassikalist läikivat kroomi? NordXi sari pakub suurepäraseid pinnaviimistluste valikut.



Harjatud must



Antiikmessing



Harjatud nikkel



Harjatud messing



Harjatud pronks

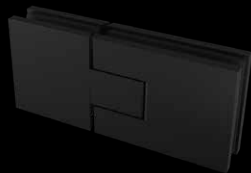

Matt must



Poleeritud kroom

* Jätame endale õiguse lisada või eemaldada pinnakatteid tootevalikust

NordX DUŠIHINGED

NordX dušihinged ühendavad ajatu disaini toimiva funktsionaalsusega ning jäävad vannitoas pea märkamatuks. Hinged on disainitud spetsiaalselt duši- ja saunauste jaoks ning tootevalikus on lisaks mitmeid nendega kokku sobivaid vannitoa klaasimise tarvikuid. NordX hinged sobivad kasutamiseks 6-10 mm paksuse karastatud klaasiga.

REGULEERITAV NULLASEND

2 mm kuuskantvõtmega saab ukse nullasendit lihtsasti reguleerida ja fikseerida.



PEIDETUD KINNITUSKRUVID

Kui kruvid on kinni keeratud, asetuvad katted klõpsuga oma kohale, andes hingele viimase lihvi.



KUUMAKINDLAD TIHENDID

Klaasitihendid on kuumakindlad kuni temperatuurini 150 °C.

KATSETATUD 100 000 TÖÖTSÜKLIGA

NordXi hinged on läbinud tsüklitesti, et tagada nende pikk kasutusiga.





HINGED

NordX 1

Materjal: messing
 Kandevõime: 50 kg paari kohta
 Ilesulguv 20° nullasendist
 Tellimisel võimalik saada ka teisi värvi toone

- | | |
|--|--|
|  Harjatud nikkel
Kood: SH.NORD1.BN |  Poleeritud kroom
Kood: SH.NORD1.P |
|  Harjatud messing
Kood: SH.NORD1.G |  Matt must
Kood: SH.NORD1.B |
|  Harjatud must
Kood: SH.NORD1.BB |  Harjatud pronks
Kood: SH.NORD1.BZ |
|  Antiikmessing
Kood: SH.NORD1.AQ | |



MÕÖTMED

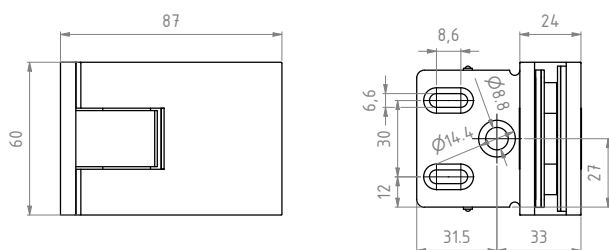

KLAASI PAKSUS JA TIHENDID

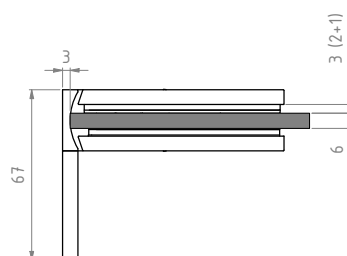

KLAASI VÄLJALÕIGE

Seina ja klaasi vahe 3 mm

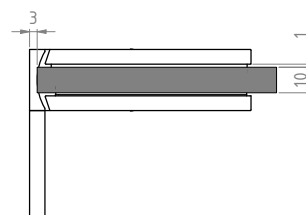
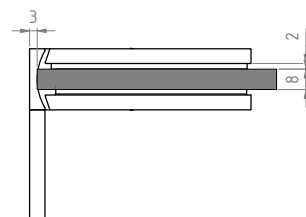
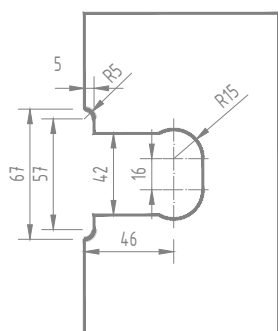

* Saadaval ka DWG-joonised

NordX 2

Materjal: messing
Kandevõime: 50 kg paari kohta
Ilesulguv 20° nullasendist
Tellimisel võimalik saada ka teisi värvitoone

- | | |
|--|--|
|  Harjatud nikkel
Kood: SH.NORD2.BN |  Poleeritud kroom
Kood: SH.NORD2.P |
|  Harjatud messing
Kood: SH.NORD2.G |  Matt must
Kood: SH.NORD2.B |
|  Harjatud must
Kood: SH.NORD2.BB |  Harjatud pronks
Kood: SH.NORD2.BZ |
|  Antiikmessing
Kood: SH.NORD2.AQ | |



MÕÖTMED

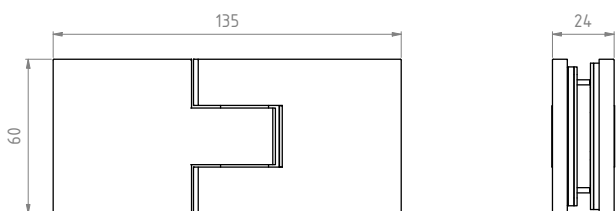

KLAASI PAKSUS JA TIHENDID

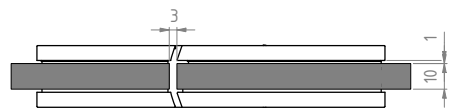
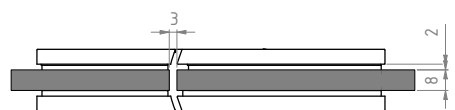
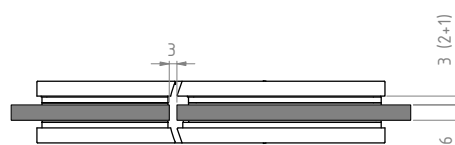

KLAASI VÄLJALÕIGE

Klaaside vahe 3 mm

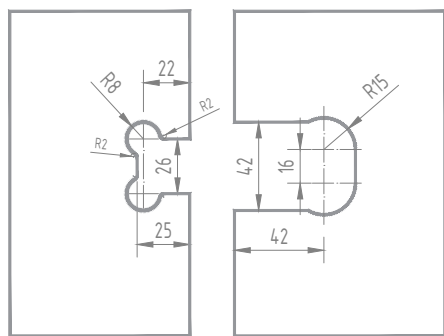

* Saadaval ka DWG-joonised

DUŠISEINA KLAMBRID

SEIN-KLAAS KLAMBER

Peidetud kinnituskruvid
Kuumakindlad tihendid
Vajab Ø14 mm ava klaasis
Tellimisel võimalik saada ka teisi värvitoone

- | | |
|---|---|
|  Harjatud nikkel
Kood: SH.CI.BN |  Poleeritud kroom
Kood: SH.CI.P |
|  Harjatud messing
Kood: SH.CI.G |  Matt must
Kood: SH.CI.B |
|  Harjatud must
Kood: SH.CI.BB |  Harjatud pronks
Kood: SH.CI.BZ |
|  Antiikmessing
Kood: SH.CI.AQ | |



MÕÖTMED

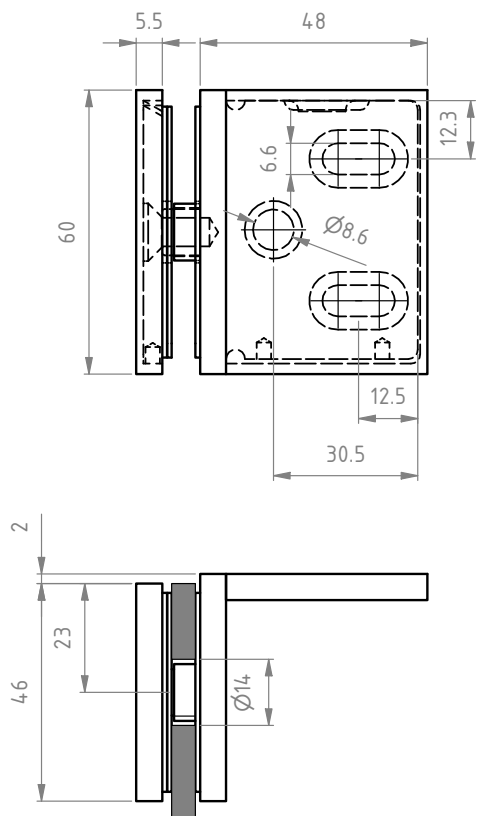

KLAASI PAKSUS JA TIHENDID

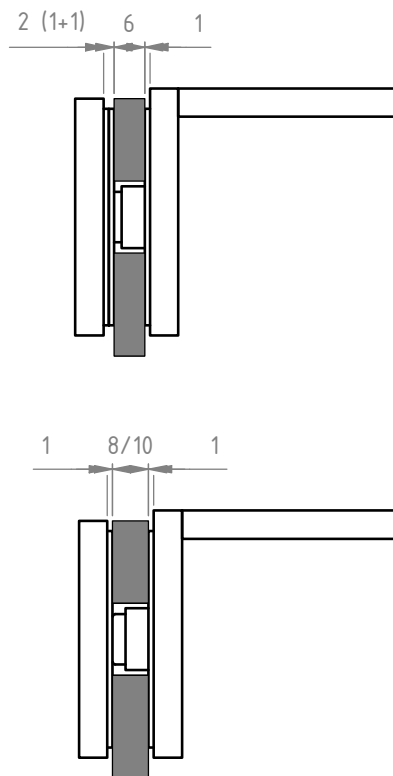

* Saadaval ka DWG-joonised

KLAAS-KLAAS KLAMBER 180°

Peidetud kinnituskruvid
Kuumakindlad tihendid
Vajab Ø14 mm avasid klaasides
Tellimisel võimalik saada ka teisi värvitoone

- | | |
|---|---|
|  Harjatud nikkel
Kood: SH.C2.BN |  Poleeritud kroom
Kood: SH.C2.P |
|  Harjatud messing
Kood: SH.C2.G |  Matt must
Kood: SH.C2.B |
|  Harjatud must
Kood: SH.C2.BB |  Harjatud pronks
Kood: SH.C2.BZ |
|  Antiikmessing
Kood: SH.C2.AQ | |



MÕÖTMED

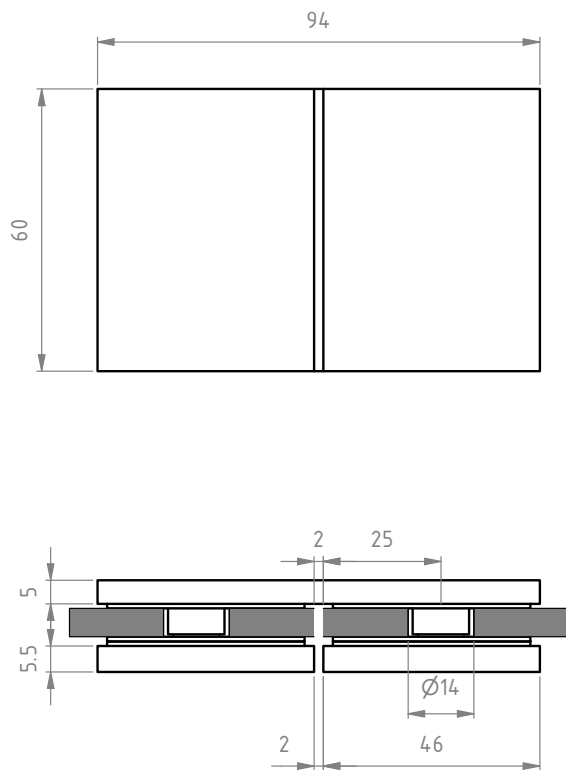

KLAASI PAKSUS JA TIHENDID

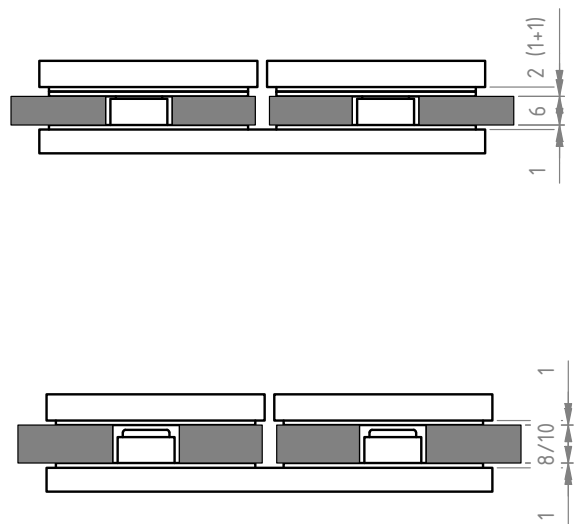

* Saadaval ka DWG-joonised

DUŠISEINA KLAMBRID

KLAAS-KLAAS KLAMBER 90°

Peidetud kinnituskruvid
Kuumakindlad tihendid
Vajab Ø14 mm avasid klaasides
Tellimisel võimalik saada ka teisi värvitoone

- | | |
|---|---|
|  Harjatud nikkel
Kood: SH.C3.BN |  Poleeritud kroom
Kood: SH.C3.P |
|  Harjatud messing
Kood: SH.C3.G |  Matt must
Kood: SH.C3.B |
|  Harjatud must
Kood: SH.C3.BB |  Harjatud pronks
Kood: SH.C3.BZ |
|  Antiikmessing
Kood: SH.C3.AQ | |



MÕÖTMED

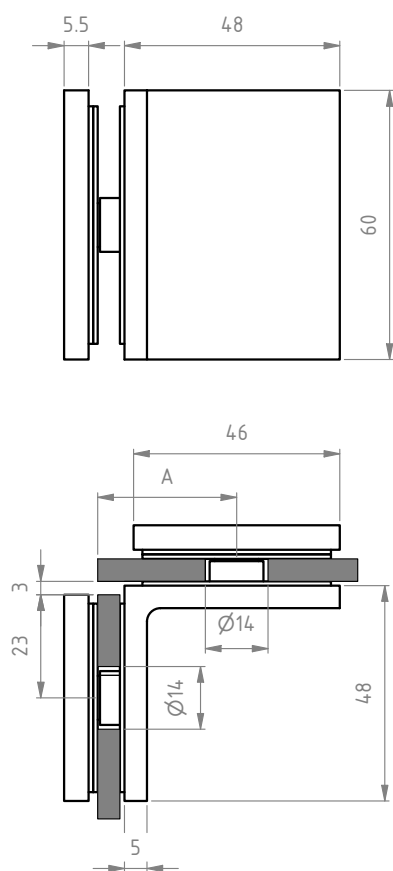

* Saadaval ka DWG-joonised

KLAASI PAKSUS JA TIHENDID

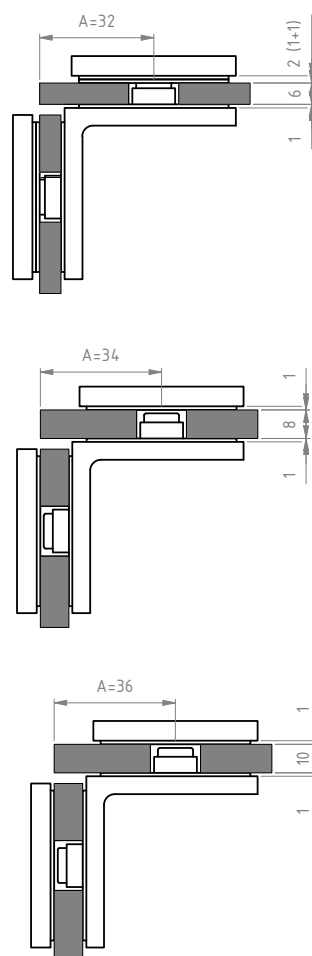









KLAASUKSE NUPUD







ÜMAR DUŠIUKSE NUPP



- | | |
|---|--|
|  Harjatud nikkel
Kood: SH.K1.BN |  Poleeritud kroom
Kood: SH.K1.P |
|  Harjatud messing
Kood: SH.K1.G |  Harjatud must
Kood: SH.K1.BB |
|  Harjatud pronks
Kood: SH.K1.BZ |  Antiikmessing
Kood: SH.K1.AQ |

ÜMAR SAUNA-/ DUŠIUKSE NUPP



- | | |
|--|---|
|  Harjatud nikkel
Kood: SH.K1W.BN |  Poleeritud kroom
Kood: SH.K1W.P |
|  Harjatud messing
Kood: SH.K1W.G |  Harjatud must
Kood: SH.K1W.BB |
|  Harjatud pronks
Kood: SH.K1W.BZ |  Antiikmessing
Kood: SH.K1W.AQ |

MÕÕTMED

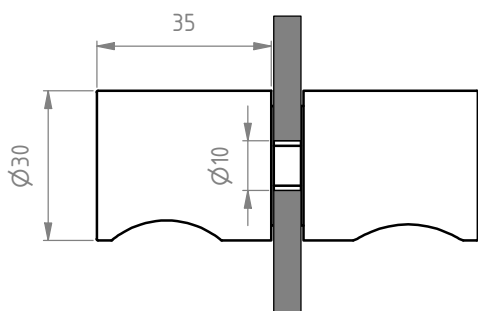



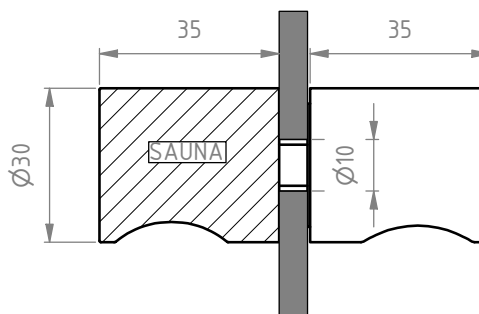



MÕÕTMED



* Materjal: messing. Saunapoolne nupp on valmistatud naturaalsest puidust ja see tuleks enne kasutamist pinnakattega töödelda.







NELINURKNE DUŠIUKSE NUPP



- | | |
|---|---|
|  Harjatud nikkel
Kood: SH.K2.BN |  Poleeritud kroom
Kood: SH.K2.P |
|  Harjatud messing
Kood: SH.K2.G |  Harjatud must
Kood: SH.K2.BB |
|  Harjatud pronks
Kood: SH.K2.BZ |  Antiikmessing
Kood: SH.K2.AQ |

NELINURKNE SAUNA-/ DUŠIUKSE NUPP



- | | |
|--|--|
|  Harjatud nikkel
SH.K2W.BN |  Poleeritud kroom
Kood: SH.K2W.P |
|  Harjatud messing
Kood: SH.K2W.G |  Harjatud must
Kood: SH.K2W.BB |
|  Harjatud pronks
Kood: SH.K2W.BZ |  Antiikmessing
Kood: SH.K2W.AQ |

MÕÕTMED

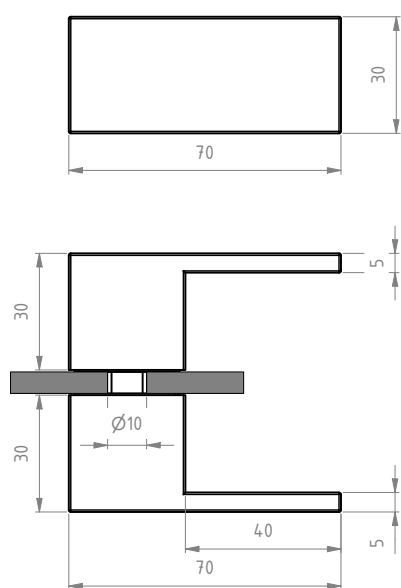

MÕÕTMED

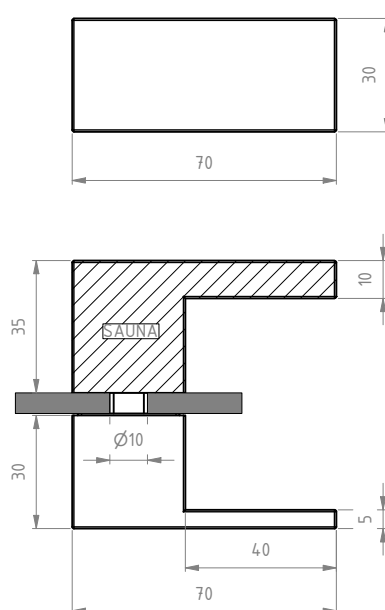

* Materjal: messing. Saunapoolne nupp on valmistatud naturaalsest puidust ja see tuleks enne kasutamist pinnakattega töödelda.

KLAASI TUGILATT

Tugilatt on suurepärase viisi dušiklaaside kinnitamiseks ülaservast. Kuna latt koosneb moodulitest, sobib see mitmesuguste dušiseinte kinnitamiseks - tuleb vaid valida õiged komponendid.

KLASSIKALINE DUŠINURK



LAIENDATUD DUŠINURK



TÄISKABIIN



**KLASSIKALINE
DUŠINIŠŠ**



**LAIENDATUD
DUŠINIŠŠ**









**AVATUD
DUŠISEIN**



KLAASI TUGILATT







REGULEERITAV KLAASIÜHENDUS



- | | |
|--|---|
|  Harjatud nikkel
Kood: SH.TC1.BN |  Poleeritud kroom
Kood: SH.TC1.P |
|  Harjatud messing
Kood: SH.TC1.G |  Harjatud must
Kood: SH.TC1.BB |
|  Harjatud pronks
Kood: SH.TC1.BZ |  Antiikmessing
Kood: SH.TC1.AQ |

REGULEERITAV SEINAÜHENDUS



- | | |
|--|---|
|  Harjatud nikkel
Kood: SH.TC2.BN |  Poleeritud kroom
Kood: SH.TC2.P |
|  Harjatud messing
Kood: SH.TC2.G |  Harjatud must
Kood: SH.TC2.BB |
|  Harjatud pronks
Kood: SH.TC2.BZ |  Antiikmessing
Kood: SH.TC2.AQ |

MÕÖTMED

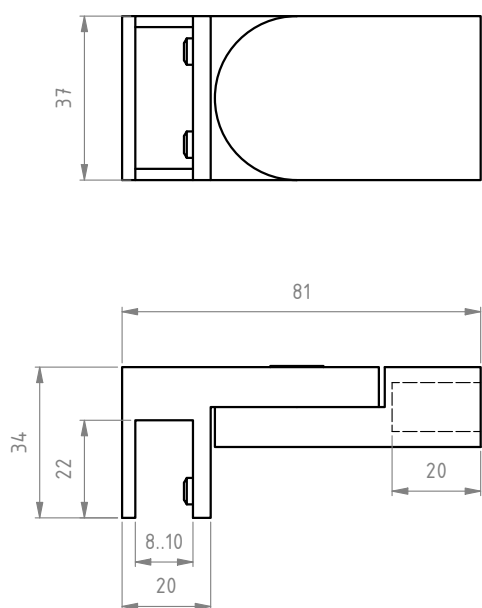



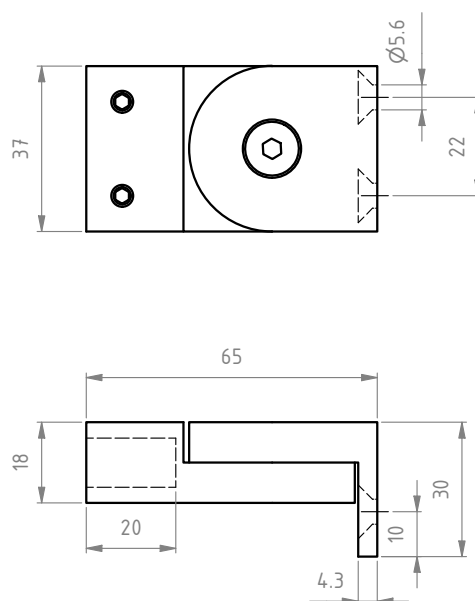



MÕÖTMED



LIHTNE SEINAÜHENDUS



- | | |
|--|---|
|  Harjatud nikkel
Kood: SH.TC3.BN |  Poleeritud kroom
Kood: SH.TC3.P |
|  Harjatud messing
Kood: SH.TC3.G |  Harjatud must
Kood: SH.TC3.BB |
|  Harjatud pronks
Kood: SH.TC3.BZ |  Antiikmessing
Kood: SH.TC3.AQ |

RISTLIITEGA ÜHENDUS



- | | |
|--|---|
|  Harjatud nikkel
Kood: SH.TC4.BN |  Poleeritud kroom
Kood: SH.TC4.P |
|  Harjatud messing
Kood: SH.TC4.G |  Harjatud must
Kood: SH.TC4.BB |
|  Harjatud pronks
Kood: SH.TC4.BZ |  Antiikmessing
Kood: SH.TC4.AQ |

MÕÕTMED

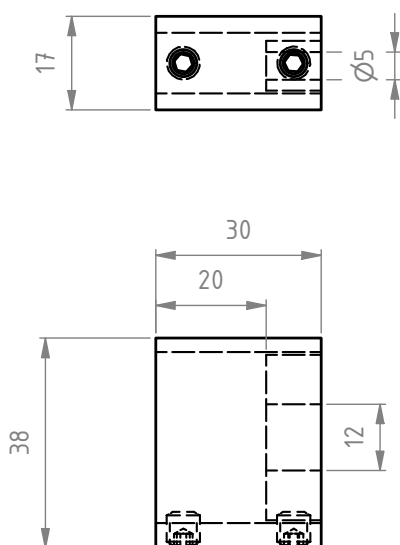

MÕÕTMED

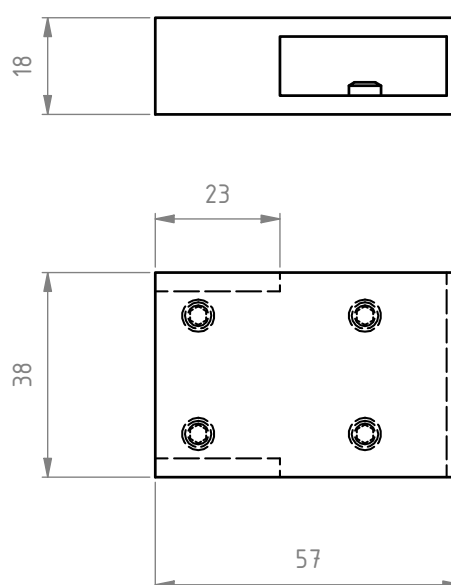

KLAASI TUGILATT

TORU 10 × 30,
PIKKUS 1 M



● Harjatud nikkel
Kood: SH.Tx1M.BN

● Harjatud messing
Kood: SH.Tx1M.G

● Harjatud pronks
Kood: SH.Tx1M.BZ

● Poleeritud kroom
Kood: SH.Tx1M.P

● Harjatud must
Kood: SH.Tx1M.BB

● Antiikmessing
Kood: SH.Tx1M.AQ

TORU 10 × 30,
PIKKUS 2 M



● Harjatud nikkel
Kood: SH.Tx2M.BN

● Harjatud messing
Kood: SH.Tx2M.G

● Harjatud pronks
Kood: SH.Tx2M.BZ

● Poleeritud kroom
Kood: SH.Tx2M.P

● Harjatud must
Kood: SH.Tx2M.BB

● Antiikmessing
Kood: SH.Tx2M.AQ

MÕÕTMED

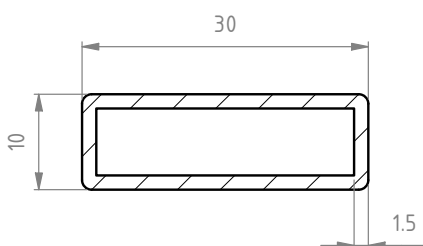

MÕÕTMED

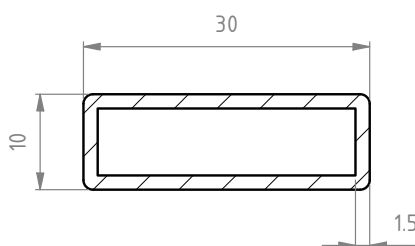



KLAASIMISPROFIILID

MADAL U-PROFIIL



- Anodeeritud, harjatud nikli efekt
Kood 8 mm klaasile: GU8L.SS
Kood 10 mm klaasile: GU10L.SS
- Haljas anodeeritud
Kood 8 mm klaasile: GU8L.P
Kood 10 mm klaasile: GU10L.P
- Anodeeritud matt must
Kood 8 mm klaasile: GU8L.B
Kood 10 mm klaasile: GU10L.B

KÕRGE U-PROFIIL



- Anodeeritud, harjatud nikli efekt
Kood 8 mm klaasile: GU8H.SS
Kood 10 mm klaasile: GU10H.SS
- Haljas anodeeritud
Kood 8 mm klaasile: GU8H.P
Kood 10 mm klaasile: GU10H.P
- Anodeeritud matt must
Kood 8 mm klaasile: GU8H.B
Kood 10 mm klaasile: GU10H.B

MÕÖTMED

8 mm klaasile

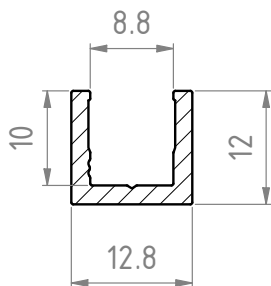

10 mm klaasile

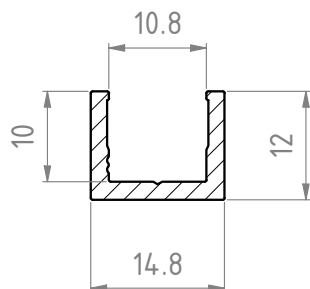

MÕÖTMED

8 mm klaasile

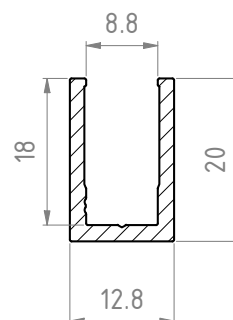

10 mm klaasile

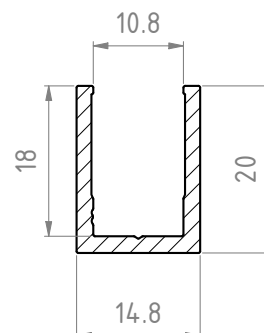

* Materjal: anodeeritud pinnaga alumiinium

R•FIX
KLAASIKINNITUSTE TOOTJA

Kurna tee 14, 75401 Kiili
Harjumaa, Eesti
Tel: +372 5685 5517
E-post: info@rfix.eu
rfix.eu