



NordX
DUSCH- & BASTUSERIER

INNEHÅLL

5	OM
8	YTBELÄGGNINGAR OCH FÄRGER
9	YTBEHANDLINGAR PÅ NORDX GÅNGJÄRN
10	DUSCHGÅNGJÄRN NORDX
12	GÅNGJÄRN
14	KLÄMMOR FÖR DUSCHVÄGG
18	DÖRRHANTAG FÖR GLAS
20	GLAS STÖDSTÅNG
26	GLASPROFILER

NordX DUSCH- & BASTUSERIER

OM

R-FIX har varit en professionell producent av glasmonteringar sedan 2010.

Vi hjälper arkitekter och byggnadsarbetare att skapa transparenta glasträcken, skärmtak, fasader och andra ansvarsfulla glaskonstruktioner.

Med duschproduktserien NordX har vi kombinerat vår erfarenhet av säkerhetsglas med modern design.

Även om den rena formen och de snygga ytbeläggningarna drar blickarna till sig, är hjärtat i NordX överlägsen funktionalitet.

Välkommen till NordX-världen!





YTBELÄGGNINGAR OCH FÄRGER



Borstad svart
Kod: BB



Antik mässing
Kod: AQ



Borstad nickel
Kod: BN



Borstad mässing
Kod: G



Borstad brons
Kod: BZ

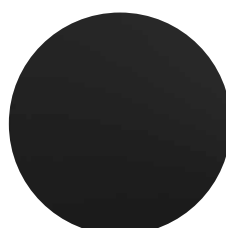

Matt svart
Kod: B



Polerad krom
Kod: P

* Vi förbehåller oss rätten att lägga till eller ta bort ytbehandlingar från vårt sortiment på begäran

** Alla ytbehandlingar är inte tillgängliga för alla tillbehör

YTBEHANDLINGAR PÅ NordX GÅNGJÄRN

Är stilen i ditt badrum naturlig, minimalistisk eller lyxig? Behöver du en vintage bronsaccentuering eller föredrar du klassiskt glänsande krom? NordX-serien har ett stort urval av ytbehandlingar.



Borstad svart



Antik mässing



Borstad nickel



Borstad mässing



Borstad brons

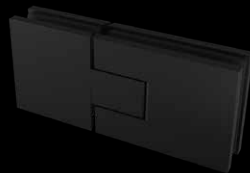

Matt svart



Polerad krom

* Vi förbehåller oss rätten att lägga till eller ta bort ytbehandlingar från vårt sortiment på begäran

DUSCHGÅNGJÄRN NordX

Med NordX duschgångjärn möts minimalistisk design och professionell teknik för en sömlös badrumsupplevelse. Gångjärnen är avsedda för dusch- eller bastudörrar och kompletteras med en rad tillbehör. NordX gångjärnen kan bära 6-10 mm härdat glas.

JUSTERBART NOLLÄGE

Med hjälp av en 2 mm HEX-nyckel kan dörrens nolläge justeras och fixeras smidigt.



DOLDA MONTERINGSSKRUVAR

Efter att skruvarna har dragits åt kan täcklocken tryckas på plats med ett mjukt klick, vilket gör gångjärnet klart.



TÄTNINGAR AV VÄRMEBESTÄNDIGT GLAS

För att vara lämpliga för bastudörrar är alla tätningar värmebeständiga upp till 150 °C.

TESTAD MED 100,000 ARBETSCYKLER

NordX gångjärnen har genomgått ett cykeltest för att garantera lång livslängd.





GÅNGJÄRN

NordX 1

Material: mässing
Bärkapacitet: 50 kg per par
Självstängande 20° från nolläge
Extra färger tillgängliga på begäran

- | | |
|--|---|
|  Borstad nickel
Kod: SH.NORD1.BN |  Polerad krom
Kod: SH.NORD1.P |
|  Borstad mässing
Kod: SH.NORD1.G |  Matt svart
Kod: SH.NORD1.B |
|  Borstad svart
Kod: SH.NORD1.BB |  Borstad brons
Kod: SH.NORD1.BZ |
|  Antik mässing
Kod: SH.NORD1.AQ | |



MÅTT

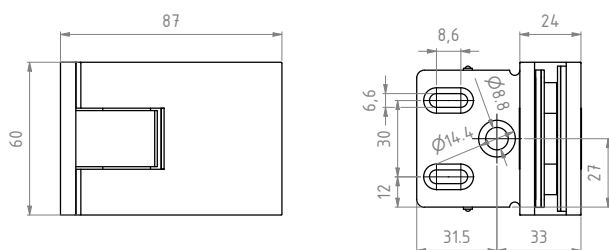

GLASTJOCKLEK OCH TÄTNINGAR

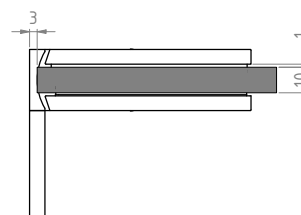
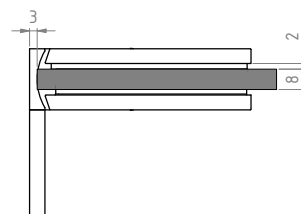
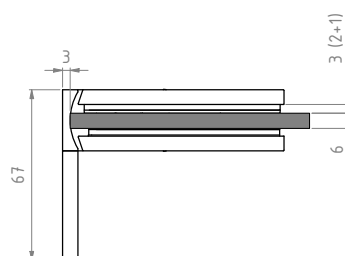

GLASUTSKÄRNING



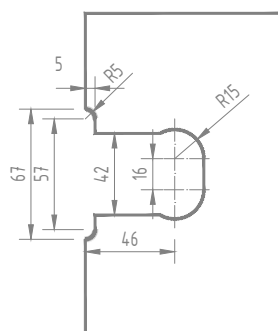



Avstånd vägg till glas 3 mm



* DWG-ritningar tillgängliga på begäran

NordX 2

Material: mässing
Bärkapacitet: 50 kg per par
Självstängande 20° från nolläge
Extra färger tillgängliga på begäran

- | | |
|--|---|
|  Borstad nickel
Kod: SH.NORD2.BN |  Polerad krom
Kod: SH.NORD2.P |
|  Borstad mässing
Kod: SH.NORD2.G |  Matt svart
Kod: SH.NORD2.B |
|  Borstad svart
Kod: SH.NORD2.BB |  Borstad brons
Kod: SH.NORD2.BZ |
|  Antik mässing
Kod: SH.NORD2.AQ | |



MÅTT

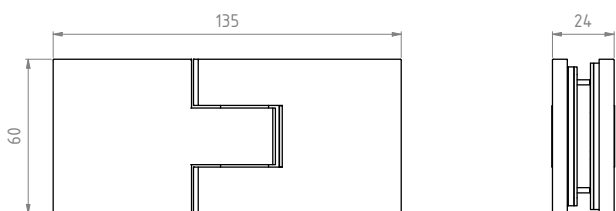

GLASTJOCKLEK OCH TÄTNINGAR

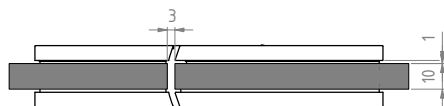
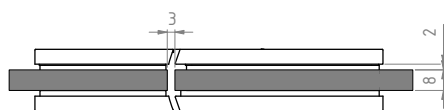
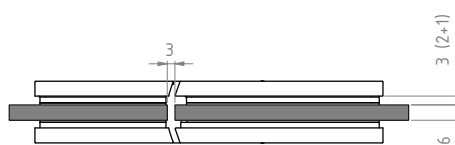

GLASUTSKÄRNING

Avstånd glas-glas 3mm

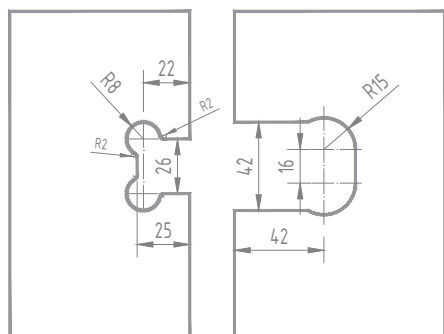







* DWG-ritningar tillgängliga på begäran

KLÄMMOR FÖR DUSCHVÄGG

VÄGG-TILL-GLAS KLÄMMA

Dolda monteringskruvar
Tätningar av värmebeständigt glas
Kräver $\varnothing 14$ mm glasutskärning
Extra färger tillgängliga på begäran

- | | |
|---|--|
|  Borstad nickel
Kod: SH.C1.BN |  Polerad krom
Kod: SH.C1.P |
|  Borstad mässing
Kod: SH.C1.G |  Matt svart
Kod: SH.C1.B |
|  Borstad svart
Kod: SH.C1.BB |  Borstad brons
Kod: SH.C1.BZ |
|  Antik mässing
Kod: SH.C1.AQ | |



MÅTT

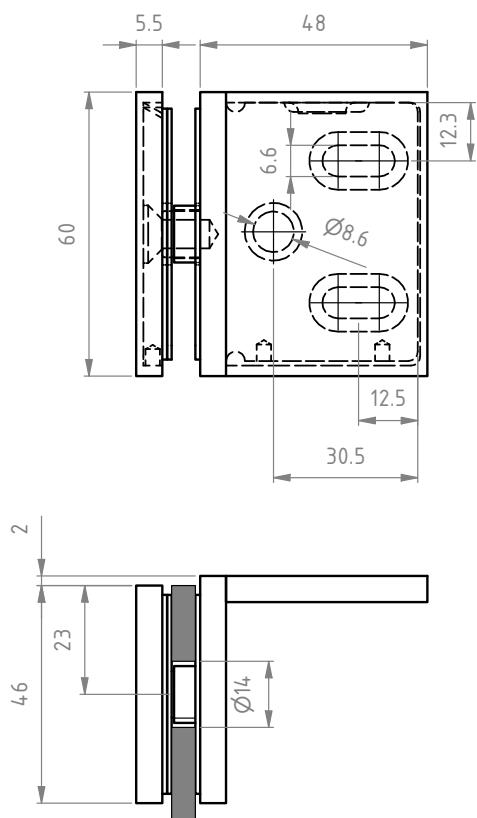



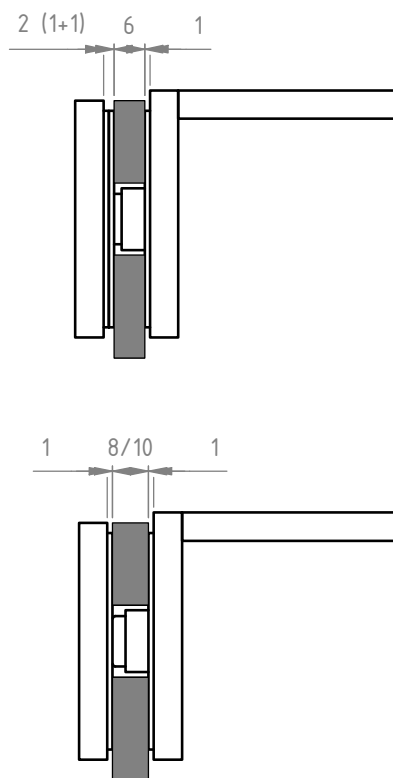



GLASTJOCKLEK OCH TÄTNINGAR



* DWG-ritningar tillgängliga på begäran

GLAS TILL GLAS KLÄMMA 180°

Dolda monteringskruvar
Tätningar av värmebeständigt glas
Kräver $\varnothing 14$ mm glasutskärningar
Extra färger tillgängliga på begäran

- | | | | |
|---|---------------------------------|---|--------------------------------|
|  | Borstad nickel
Kod: SH.C2.BN |  | Polerad krom
Kod: SH.C2.P |
|  | Borstad mässing
Kod: SH.C2.G |  | Matt svart
Kod: SH.C2.B |
|  | Borstad svart
Kod: SH.C2.BB |  | Borstad brons
Kod: SH.C2.BZ |
|  | Antik mässing
Kod: SH.C2.AQ | | |



MÅTT

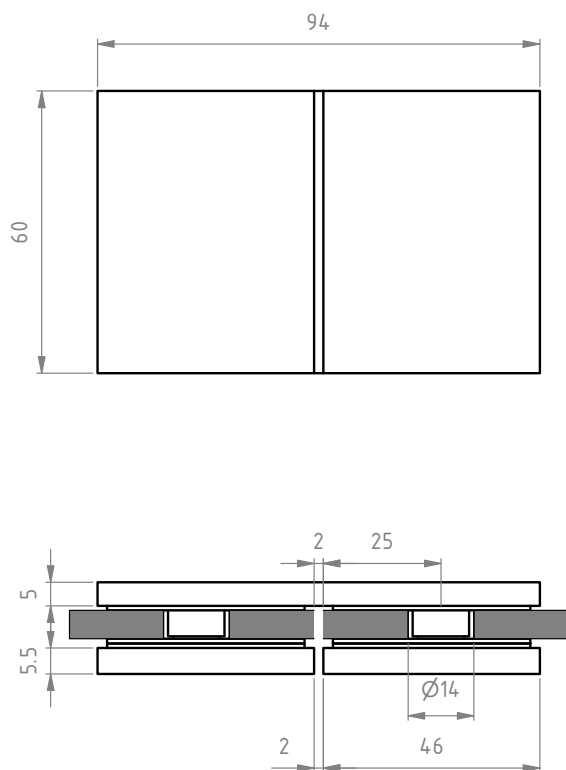

GLASTJOCKLEK OCH TÄTNINGAR

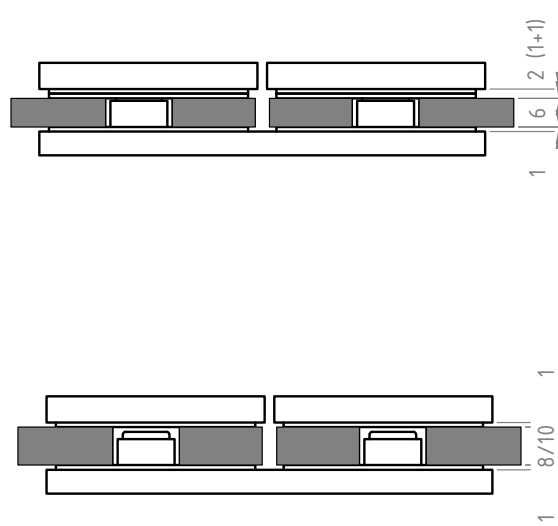







* DWG-ritningar tillgängliga på begäran

KLÄMMOR FÖR DUSCHVÄGG

GLAS TILL GLAS KLÄMMA 90°

Dolda monteringskruvar
Tätningar av värmebeständigt glas
Kräver $\varnothing 14$ mm glasutskärning
Extra färger tillgängliga på begäran

- | | |
|---|--|
|  Bristad nickel
Kod: SH.C3.BN |  Polerad krom
Kod: SH.C3.P |
|  Bristad mässing
Kod: SH.C3.G |  Matt svart
Kod: SH.C3.B |
|  Bristad svart
Kod: SH.C3.BB |  Bristad brons
Kod: SH.C3.BZ |
|  Antik mässing
Kod: SH.C3.AQ | |



MÅTT

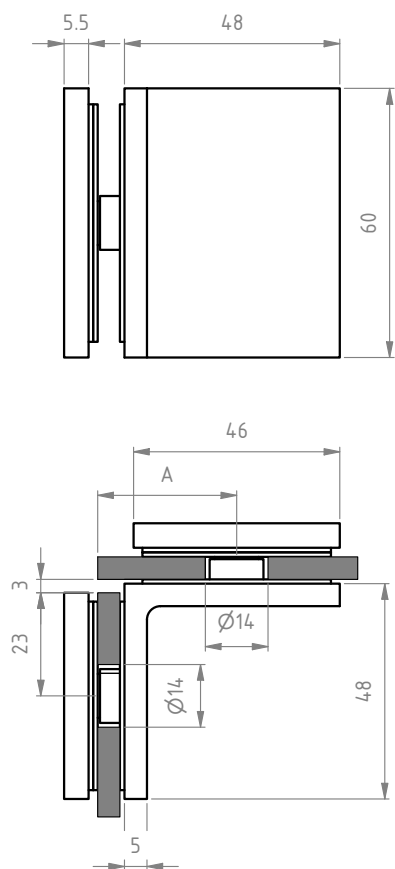

* DWG-ritningar tillgängliga på begäran

GLASTJOCKLEK OCH TÄTNINGAR

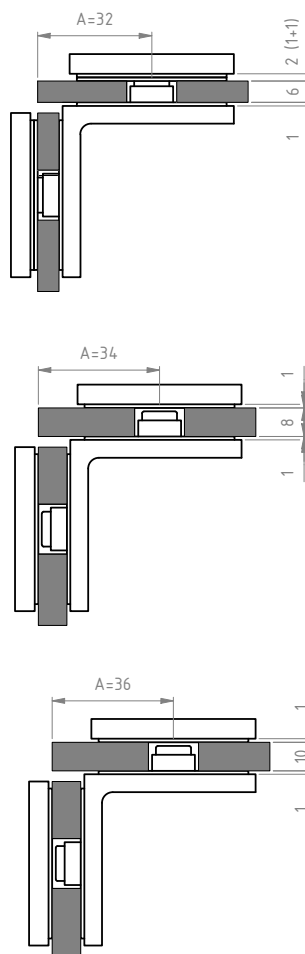



DÖRRHANDTAG FÖR GLAS







RUNT DUSCHDÖRRHANDTAG



- | | |
|---|--|
|  Borstad nickel
Kod: SH.K1.BN |  Polerad krom
Kod: SH.K1.P |
|  Borstad mässing
Kod: SH.K1.G |  Borstad svart
Kod: SH.K1.BB |
|  Borstad brons
Kod: SH.K1.BZ |  Antik mässing
Kod: SH.K1.AQ |

RUNT DÖRRHANDTAG FÖR BASTU/DUSCH



- | | |
|--|---|
|  Borstad nickel
Kod: SH.K1W.BN |  Polerad krom
Kod: SH.K1W.P |
|  Borstad mässing
Kod: SH.K1W.G |  Borstad svart
Kod: SH.K1W.BB |
|  Borstad brons
Kod: SH.K1W.BZ |  Antik mässing
Kod: SH.K1W.AQ |

MÅTT

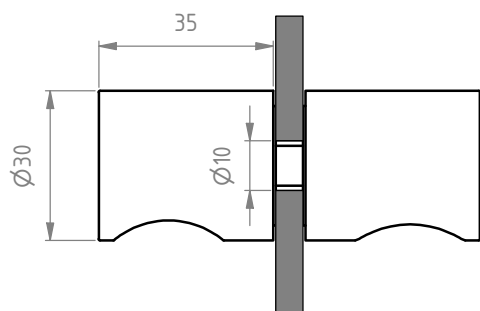



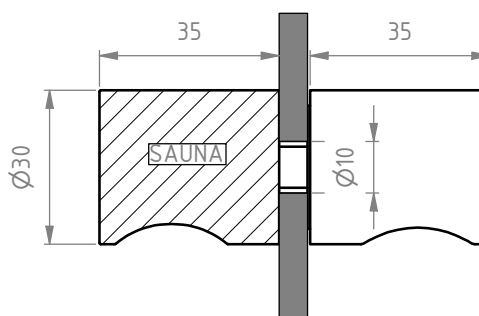



MÅTT



* Material: mässing. Bastuhandtaget är tillverkat av naturligt trä och bör beläggas före användning.







REKTANGULÄRT HANDTAG FÖR DUSCHDÖRR



- | | |
|---|--|
|  Borstad nickel
Kod: SH.K2.BN |  Polerad krom
Kod: SH.K2.P |
|  Borstad mässing
Kod: SH.K2.G |  Borstad svart
Kod: SH.K2.BB |
|  Borstad brons
Kod: SH.K2.BZ |  Antik mässing
Kod: SH.K2.AQ |

REKTANGULÄRT DÖRRHANDTAG FÖR BASTU/DUSCH



- | | |
|--|---|
|  Borstad nickel
SH.K2W.BN |  Polerad krom
Kod: SH.K2W.P |
|  Borstad mässing
Kod: SH.K2W.G |  Borstad svart
Kod: SH.K2W.BB |
|  Borstad brons
Kod: SH.K2W.BZ |  Antik mässing
Kod: SH.K2W.AQ |

MÅTT

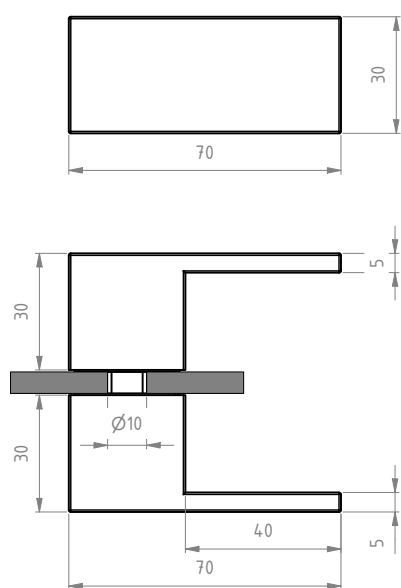

MÅTT

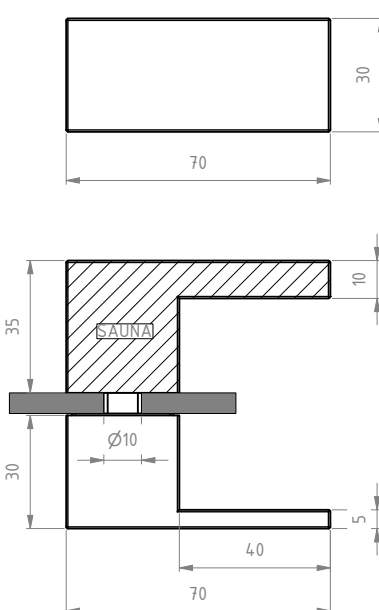

* Material: mässing. Bastuhandtaget är tillverkat av naturligt trä och bör beläggas före användning.

GLAS STÖDSTÅNG

En stödstång är en bra lösning för att fästa duschglas från den övre kanten. Tack vare moduluppbyggnaden är det möjligt att bygga många olika duschväggar genom att välja rätt komponenter.

KLASSISK HÖRNA



FÖRLÄNGT HÖRN



HEL HYTT



**KLASSISK
NICHE**



**FÖRLÄNGD
NICHE**









STIG IN



GLAS STÖDSTÅNG







GLASANSLUTNING MED JUSTERBAR VINKEL



- | | |
|--|---|
|  Borstad nickel
Kod: SH.TC1.BN |  Polerad krom
Kod: SH.TC1.P |
|  Borstad mässing
Kod: SH.TC1.G |  Borstad svart
Kod: SH.TC1.BB |
|  Borstad brons
Kod: SH.TC1.BZ |  Antik mässing
Kod: SH.TC1.AQ |

VÄGGANSLUTNING MED JUSTERBAR VINKEL



- | | |
|--|---|
|  Borstad nickel
Kod: SH.TC2.BN |  Polerad krom
Kod: SH.TC2.P |
|  Borstad mässing
Kod: SH.TC2.G |  Borstad svart
Kod: SH.TC2.BB |
|  Borstad brons
Kod: SH.TC2.BZ |  Antik mässing
Kod: SH.TC2.AQ |

MÅTT

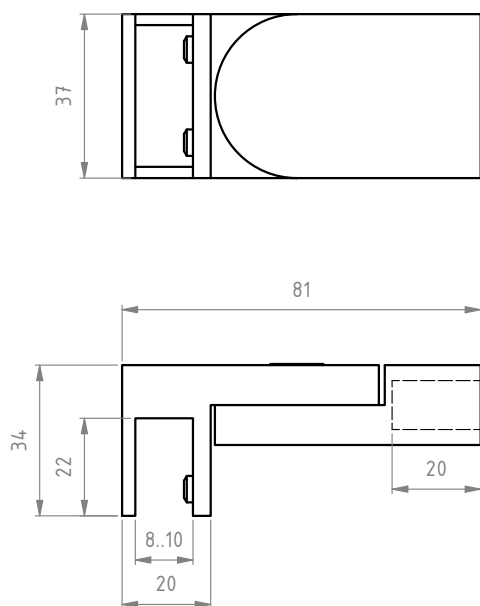



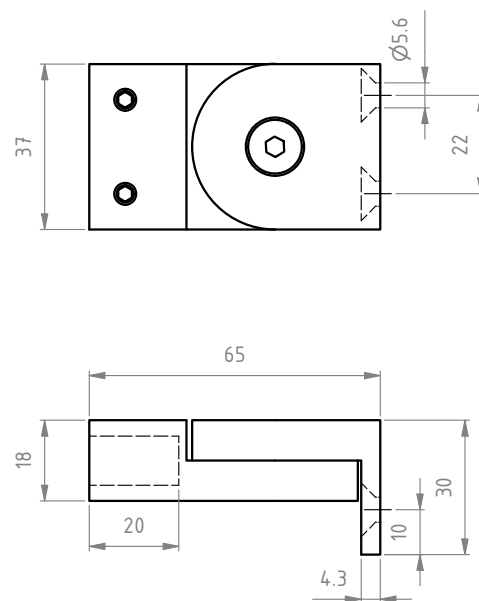



MÅTT









ENKEL VÄGGANSLUTNING



- | | |
|--|---|
|  Borstad nickel
Kod: SH.TC3.BN |  Polerad krom
Kod: SH.TC3.P |
|  Borstad mässing
Kod: SH.TC3.G |  Borstad svart
Kod: SH.TC3.BB |
|  Borstad brons
Kod: SH.TC3.BZ |  Antik mässing
Kod: SH.TC3.AQ |

KORSKOPPLING



- | | |
|--|---|
|  Borstad nickel
Kod: SH.TC4.BN |  Polerad krom
Kod: SH.TC4.P |
|  Borstad mässing
Kod: SH.TC4.G |  Borstad svart
Kod: SH.TC4.BB |
|  Borstad brons
Kod: SH.TC4.BZ |  Antik mässing
Kod: SH.TC4.AQ |

MÅTT

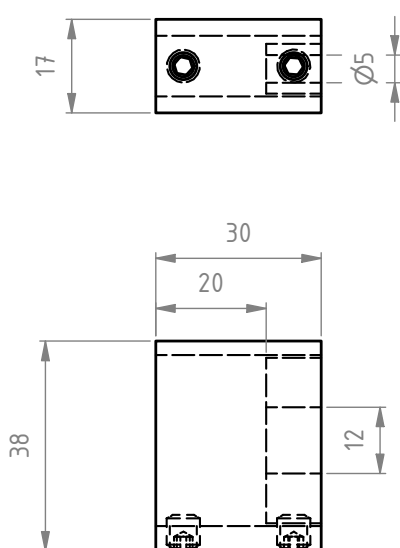



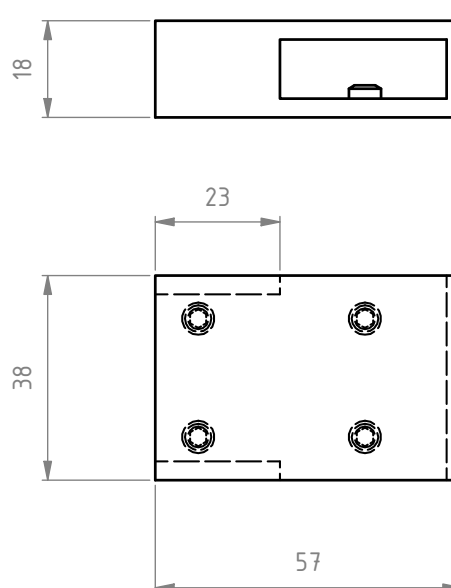



MÅTT



GLAS STÖDSTÅNG







RÖR 10X30, LÄNGD 1 M



- | | |
|---|--|
|  Borstad nickel
Kod: SH.Tx1M.BN |  Polerad krom
Kod: SH.Tx1M.P |
|  Borstad mässing
Kod: SH.Tx1M.G |  Borstad svart
Kod: SH.Tx1M.BB |
|  Borstad brons
Kod: SH.Tx1M.BZ |  Antik mässing
Kod: SH.Tx1M.AQ |

RÖR 10X30, LÄNGD 2 M



- | | |
|---|--|
|  Borstad nickel
Kod: SH.Tx2M.BN |  Polerad krom
Kod: SH.Tx2M.P |
|  Borstad mässing
Kod: SH.Tx2M.G |  Borstad svart
Kod: SH.Tx2M.BB |
|  Borstad brons
Kod: SH.Tx2M.BZ |  Antik mässing
Kod: SH.Tx2M.AQ |

MÅTT

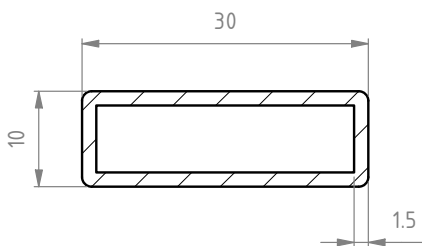

MÅTT

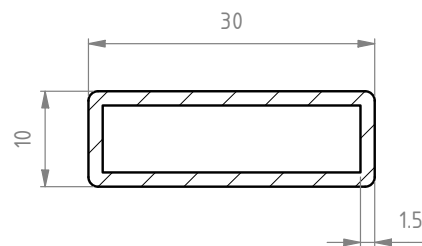



GLASPROFILER

LÅG U-PROFIL



- Effektanod i borstad nickel
Kod for 8mm glass : GU8L.SS
Kod for 10mm glass: GU10L.SS
- Elektropolerad anod
Kod for 8mm glass: GU8L.P
Kod for 10mm glass: GU10L.P
- Matt svart anod
Kod for 8mm glass: GU8L.B
Kod for 10mm glass: GU10L.B

HÖG U-PROFIL



- Effektanod i borstad nickel
Kod for 8mm glass : GU8H.SS
Kod for 10mm glass: GU10H.SS
- Elektropolerad anod
Kod for 8mm glass: GU8H.P
Kod for 10mm glass: GU10H.P
- Matt svart anod
Kod for 8mm glass: GU8H.B
Kod for 10mm glass: GU10H.B

MÅTT

8 mm glas

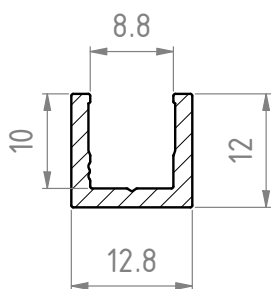

10 mm glas

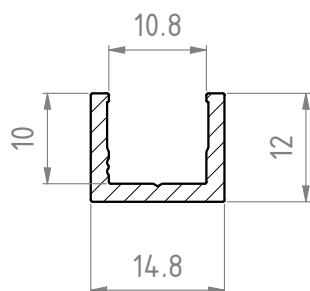

MÅTT

8 mm glas

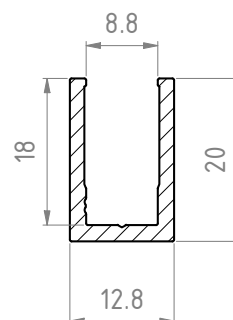

10 mm glas

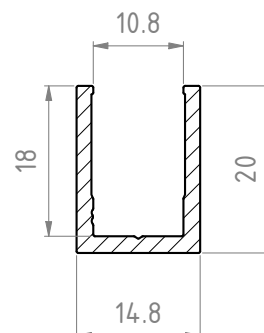

* Material: aluminium med anodiserad yta

R·FIX
GLASS FIXINGS PRODUCER

14 Kurna Street, Kiili 75401,
Harju län, Estland
info@rfix.eu
rfix.eu