



**NordX**  
**SHOWER & SAUNA SERIES**



---

# CONTENT

5	ABOUT
8	COATINGS AND COLOURS
9	SURFACE FINISHES OF NordX HINGES
10	SHOWER HINGES NordX
12	HINGES
14	SHOWER WALL CLAMPS
18	GLASS DOOR KNOBS
20	GLASS SUPPORT BAR
26	GLAZING PROFILES

# NordX SHOWER & SAUNA SERIES

---

# ABOUT

R-FIX has been a producer of architectural glass fixings since 2010.

We assist architects and construction professionals in creating safe glass railings, canopies, facades and other responsible glass structures.

With the NordX shower product series we have combined our safety glazing experience with timeless design.

While clean form and pleasant coatings catch the eye, the heart of NordX is superior functionality.

Welcome to the NordX world!







---

# COATINGS AND COLOURS



Brushed black  
Code: BB



Antique brass  
Code: AQ



Brushed nickel  
Code: BN



Brushed brass  
Code: G



Brushed bronze  
Code: BZ

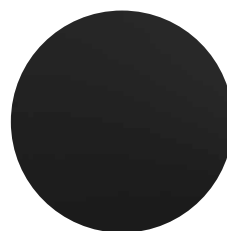

Matte black  
Code: B



Polished chrome  
Code: P

\* We reserve the right to add or remove coatings from our selection on demand  
\*\* Not all coatings are available on all accessories



---

# SURFACE FINISHES OF NordX HINGES

Is the style of your bathroom natural, minimalistic or luxurious? Do you need a vintage bronze accent or do you prefer classic shiny chrome? The NordX range boasts a great choice of surface finishes.



Brushed black



Antique brass



Brushed nickel



Brushed brass



Brushed bronze



Matte black



Polished chrome

\* We reserve the right to add or remove coatings from our selection on demand

---

# SHOWER HINGES NordX

With NordX shower hinges, minimalistic design meets professional engineering for a seamless bathroom experience. The hinges are designed for shower or sauna doors and are accompanied by a range of accessories. NordX hinges can hold 6-10-mm tempered glass.

---

## ADJUSTABLE ZERO POSITION

Using 2-mm HEX key, the door's zero position can be adjusted and fixed smoothly.



---

## HIDDEN FIXING SCREWS

After tightening the screws, the cover caps can be pressed into place with a smooth click, finishing the hinge.



---

## HEAT-RESISTANT GLASS GASKETS

To be suitable for sauna doors, all gaskets are heat resistant up to 150 °C.

---

## TESTED WITH 100,000 WORKING CYCLES

NordX hinges have passed the cycle test to guarantee their long service life.





# HINGES

## NordX 1

Material: brass  
 Load capacity: 50 kg per pair  
 Self-closing 20° from zero position  
 Extra colours available upon request

- |   |   |
|---|---|
|  Brushed nickel<br>Code: SH.NORD1.BN |  Polished chrome<br>Code: SH.NORD1.P |
|  Brushed brass<br>Code: SH.NORD1.G   |  Matte black<br>Code: SH.NORD1.B     |
|  Brushed black<br>Code: SH.NORD1.BB  |  Brushed bronze<br>Code: SH.NORD1.BZ |
|  Antique brass<br>Code: SH.NORD1.AQ  |   |



### MEASUREMENTS

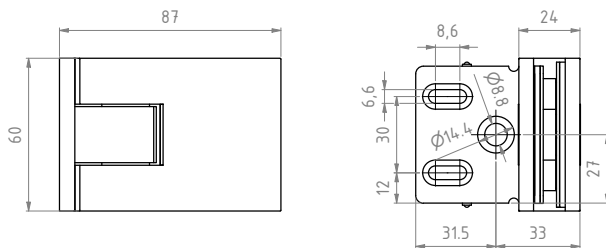

### GLASS THICKNESS AND GASKETS

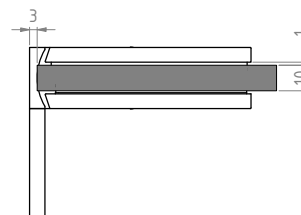
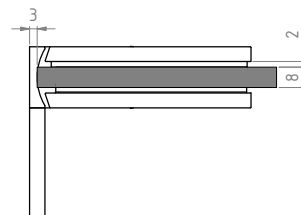
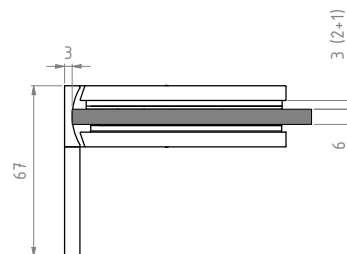

### GLASS CUTOUT

Wall-to-glass gap 3 mm

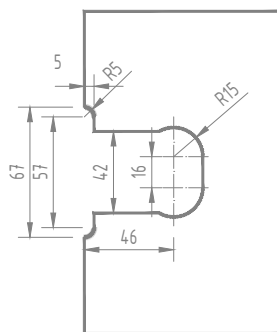



\* DWG drawings available upon request



## NordX 2

Material: brass  
 Load capacity: 50 kg per pair  
 Self-closing 20° from zero position  
 Extra colours available upon request

- |   |   |
|---|---|
|  Brushed nickel<br>Code: SH.NORD2.BN |  Polished chrome<br>Code: SH.NORD2.P |
|  Brushed brass<br>Code: SH.NORD2.G   |  Matte black<br>Code: SH.NORD2.B     |
|  Brushed black<br>Code: SH.NORD2.BB  |  Brushed bronze<br>Code: SH.NORD2.BZ |
|  Antique brass<br>Code: SH.NORD2.AQ  |   |



### MEASUREMENTS

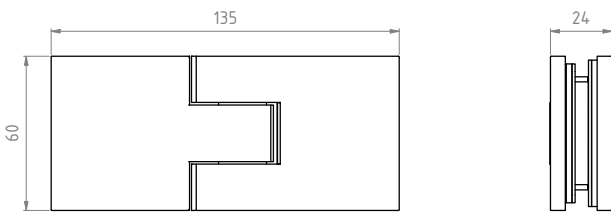

### GLASS THICKNESS AND GASKETS

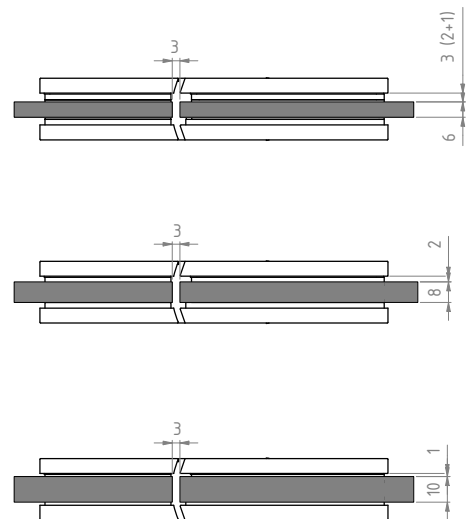

### GLASS CUTOUT

Glass-to-glass gap 3 mm

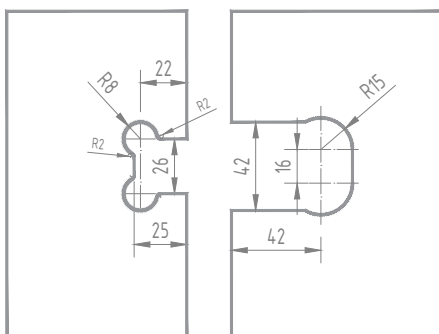







\* DWG drawings available upon request

# SHOWER WALL CLAMPS

## WALL-TO-GLASS CLAMP

Hidden fixing screws  
 Heat-resistant glass gaskets  
 Requires Ø14 mm glass cutout  
 Extra colours available upon request

- |  |  |
|--|--|
|  Brushed nickel<br>Code: SH.CI.BN |  Polished chrome<br>Code: SH.CI.P |
|  Brushed brass<br>Code: SH.CI.G   |  Matte black<br>Code: SH.CI.B     |
|  Brushed black<br>Code: SH.CI.BB  |  Brushed bronze<br>Code: SH.CI.BZ |
|  Antique brass<br>Code: SH.CI.AQ  |  |



### MEASUREMENTS

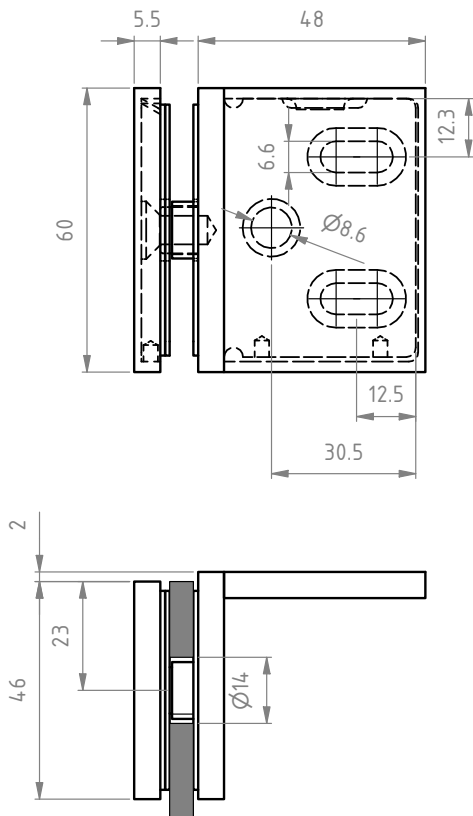



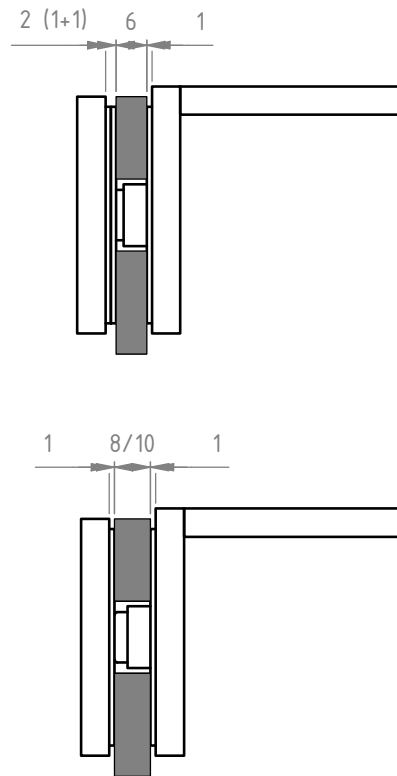



### GLASS THICKNESS AND GASKETS



\* DWG drawings available upon request

## GLASS-TO-GLASS CLAMP 180°

Hidden fixing screws  
Heat-resistant glass gaskets  
Requires Ø14 mm glass cutouts  
Extra colours available upon request

- |  |  |
|--|--|
|  Brushed nickel<br>Code: SH.C2.BN |  Polished chrome<br>Code: SH.C2.P |
|  Brushed brass<br>Code: SH.C2.G   |  Matte black<br>Code: SH.C2.B     |
|  Brushed black<br>Code: SH.C2.BB  |  Brushed bronze<br>Code: SH.C2.BZ |
|  Antique brass<br>Code: SH.C2.AQ  |  |



### MEASUREMENTS

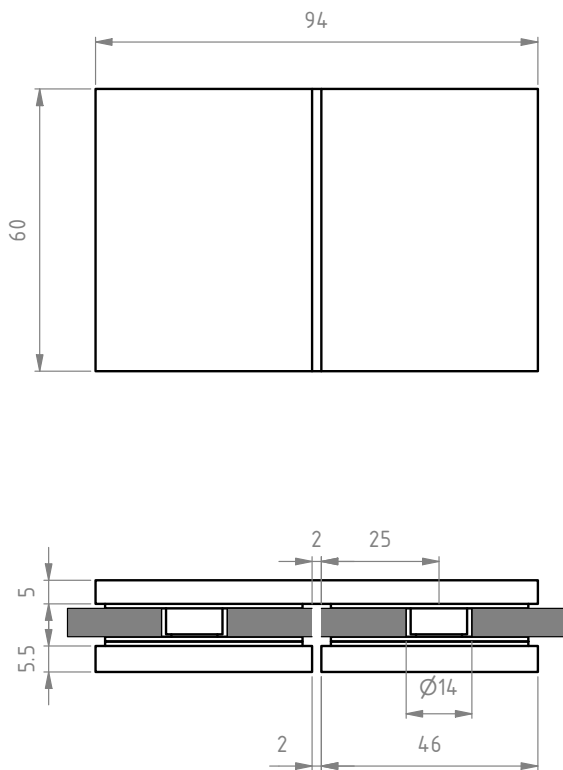

### GLASS THICKNESS AND GASKETS

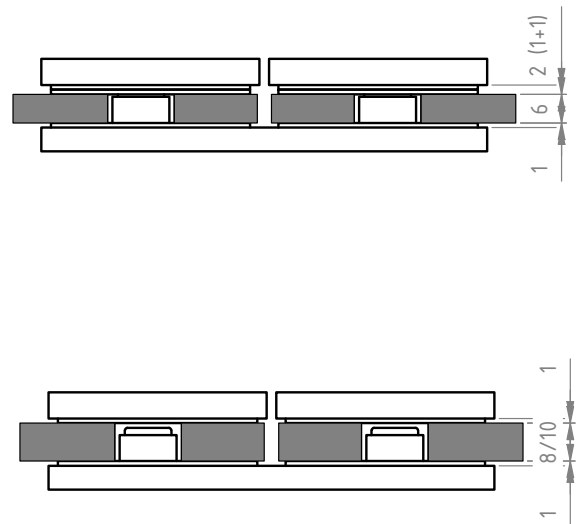







\* DWG drawings available upon request

# SHOWER WALL CLAMPS

## GLASS-TO-GLASS CLAMP 90°

Hidden fixing screws  
 Heat-resistant glass gaskets  
 Requires Ø14 mm glass cutout  
 Extra colours available upon request

- |  |  |
|--|--|
|  Brushed nickel<br>Code: SH.C3.BN |  Polished chrome<br>Code: SH.C3.P |
|  Brushed brass<br>Code: SH.C3.G   |  Matte black<br>Code: SH.C3.B     |
|  Brushed black<br>Code: SH.C3.BB  |  Brushed bronze<br>Code: SH.C3.BZ |
|  Antique brass<br>Code: SH.C3.AQ  |  |



### MEASUREMENTS

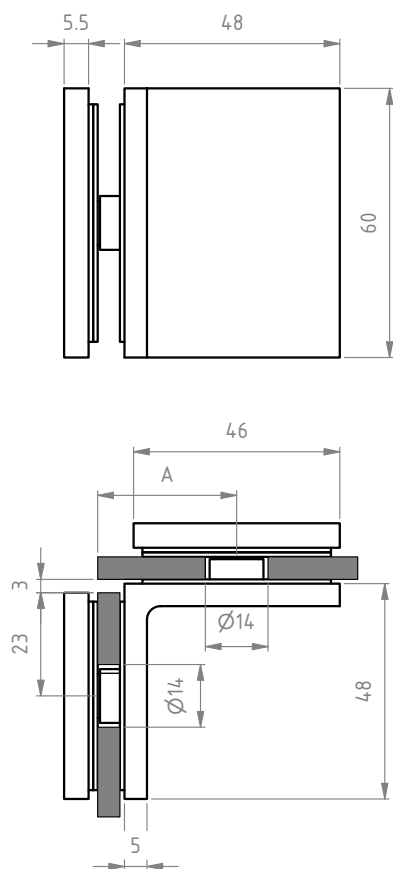

\* DWG drawings available upon request

### GLASS THICKNESS AND GASKETS

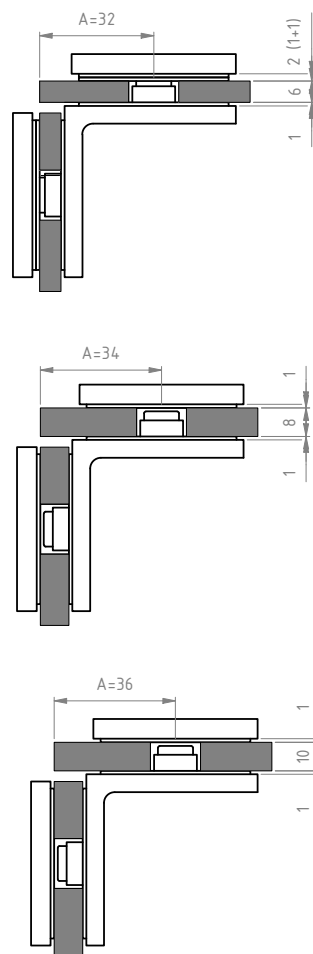











# GLASS DOOR KNOBS







## ROUND SHOWER DOOR KNOB



## ROUND SAUNA/ SHOWER DOOR KNOB



- |  |   |
|--|---|
|  Brushed nickel<br>Code: SH.K1.BN  |  Polished chrome<br>Code: SH.K1.P |
|  Brushed brass<br>Code: SH.K1.G   |  Brushed black<br>Code: SH.K1.BB |
|  Brushed bronze<br>Code: SH.K1.BZ |  Antique brass<br>Code: SH.K1.AQ |

- |   |  |
|---|--|
|  Brushed nickel<br>Code: SH.K1W.BN  |  Polished chrome<br>Code: SH.K1W.P |
|  Brushed brass<br>Code: SH.K1W.G   |  Brushed black<br>Code: SH.K1W.BB |
|  Brushed bronze<br>Code: SH.K1W.BZ |  Antique brass<br>Code: SH.K1W.AQ |

### MEASUREMENTS

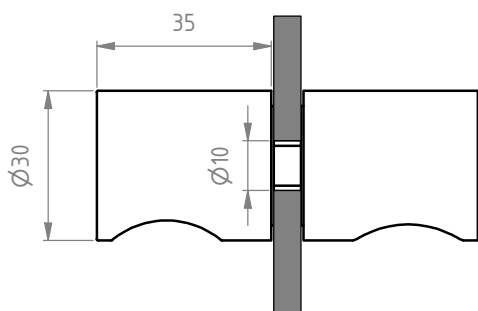



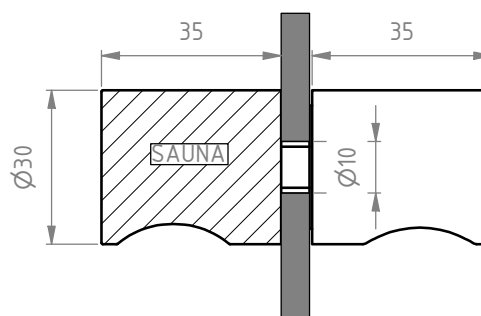



### MEASUREMENTS



\* Material: brass. Sauna side knob is made of natural wood and should be coated before use.







## RECTANGULAR SHOWER DOOR KNOB



- |  |  |
|--|--|
|  Brushed nickel<br>Code: SH.K2.BN |  Polished chrome<br>Code: SH.K2.P |
|  Brushed brass<br>Code: SH.K2.G   |  Brushed black<br>Code: SH.K2.BB  |
|  Brushed bronze<br>Code: SH.K2.BZ |  Antique brass<br>Code: SH.K2.AQ  |

## RECTANGULAR SAUNA/ SHOWER DOOR KNOB



- |   |   |
|---|---|
|  Brushed nickel<br>SH.K2W.BN       |  Polished chrome<br>Code: SH.K2W.P |
|  Brushed brass<br>Code: SH.K2W.G   |  Brushed black<br>Code: SH.K2W.BB  |
|  Brushed bronze<br>Code: SH.K2W.BZ |  Antique brass<br>Code: SH.K2W.AQ  |

### MEASUREMENTS

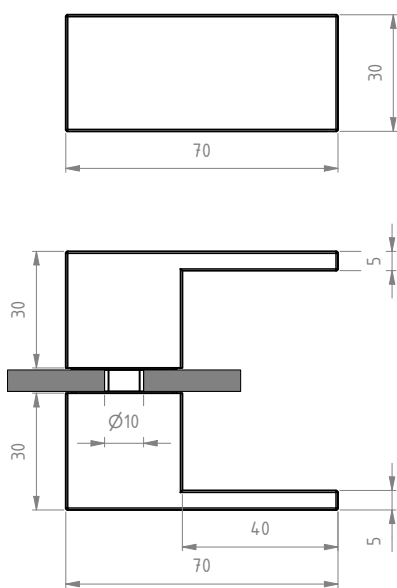

### MEASUREMENTS

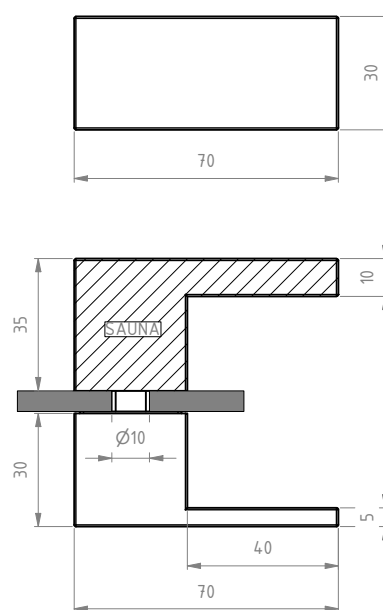

\* Material: brass. Sauna side knob is made of natural wood and should be coated before use.

---

# GLASS SUPPORT BAR

A support bar is a good solution for fixing shower glass from the upper edge. Thanks to its modularity, it is possible to support many shower enclosures just by choosing the right components.

## CLASSIC CORNER



## EXTENDED CORNER



## FULL CABIN





---

**CLASSIC  
NICHE**



**EXTENDED  
NICHE**



**WALK-IN**



# GLASS SUPPORT BAR

## GLASS CONNECTOR WITH ADJUSTABLE ANGLE



- Brushed nickel  
Code: SH.TC1.BN
- Polished chrome  
Code: SH.TC1.P
- Brushed brass  
Code: SH.TC1.G
- Brushed black  
Code: SH.TC1.BB
- Brushed bronze  
Code: SH.TC1.BZ
- Antique brass  
Code: SH.TC1.AQ

## WALL CONNECTOR WITH ADJUSTABLE ANGLE



- Brushed nickel  
Code: SH.TC2.BN
- Polished chrome  
Code: SH.TC2.P
- Brushed brass  
Code: SH.TC2.G
- Brushed black  
Code: SH.TC2.BB
- Brushed bronze  
Code: SH.TC2.BZ
- Antique brass  
Code: SH.TC2.AQ

### MEASUREMENTS

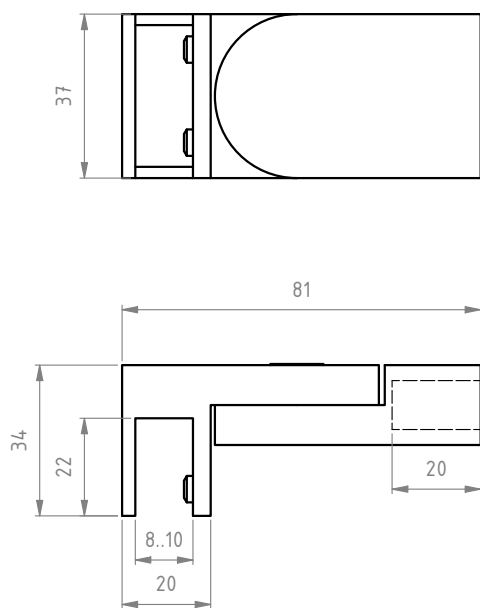



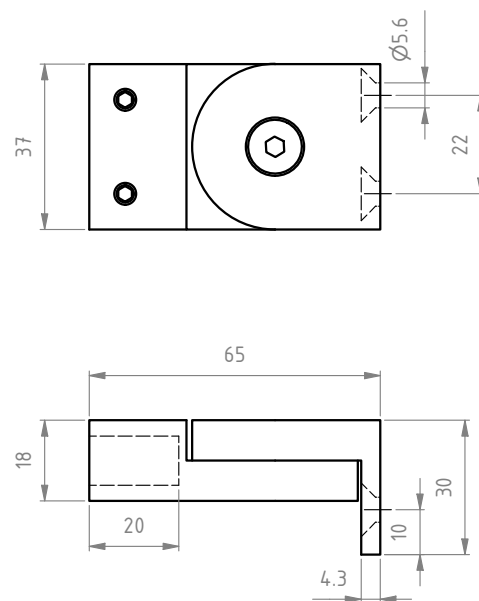



### MEASUREMENTS









## SIMPLE WALL CONNECTOR



- |   |   |
|---|---|
|  Brushed nickel<br>Code: SH.TC3.BN |  Polished chrome<br>Code: SH.TC3.P |
|  Brushed brass<br>Code: SH.TC3.G   |  Brushed black<br>Code: SH.TC3.BB  |
|  Brushed bronze<br>Code: SH.TC3.BZ |  Antique brass<br>Code: SH.TC3.AQ  |

## CROSS JOINT CONNECTOR



- |   |   |
|---|---|
|  Brushed nickel<br>Code: SH.TC4.BN |  Polished chrome<br>Code: SH.TC4.P |
|  Brushed brass<br>Code: SH.TC4.G   |  Brushed black<br>Code: SH.TC4.BB  |
|  Brushed bronze<br>Code: SH.TC4.BZ |  Antique brass<br>Code: SH.TC4.AQ  |

### MEASUREMENTS

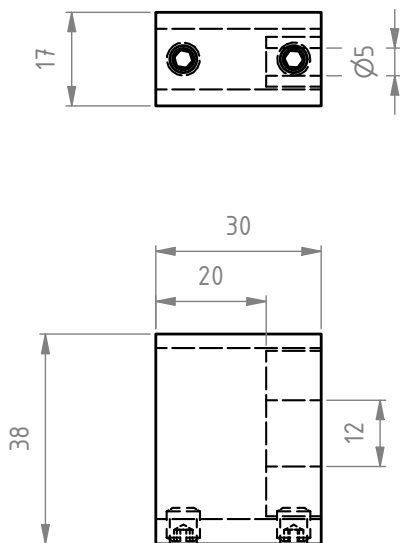

### MEASUREMENTS

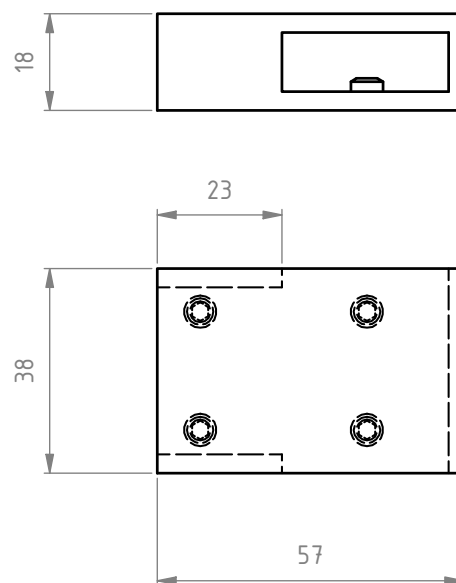

---

# GLASS SUPPORT BAR

## TUBE 10x30, LENGTH 1M



Brushed nickel  
Code: SH.Tx1M.BN

Brushed brass  
Code: SH.Tx1M.G

Brushed bronze  
Code: SH.Tx1M.BZ

Polished chrome  
Code: SH.Tx1M.P

Brushed black  
Code: SH.Tx1M.BB

Antique brass  
Code: SH.Tx1M.AQ

## TUBE 10x30, LENGTH 2M



Brushed nickel  
Code: SH.Tx2M.BN

Brushed brass  
Code: SH.Tx2M.G

Brushed bronze  
Code: SH.Tx2M.BZ

Polished chrome  
Code: SH.Tx2M.P

Brushed black  
Code: SH.Tx2M.BB

Antique brass  
Code: SH.Tx2M.AQ

---

### MEASUREMENTS

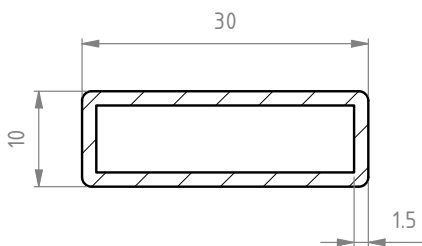

---

### MEASUREMENTS

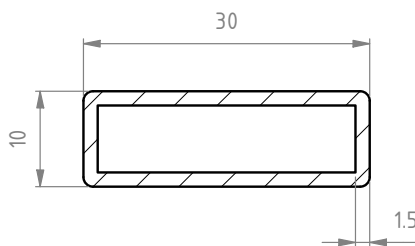







# GLAZING PROFILES

## LOW U-PROFILE



- 
 Brushed Nickel effect anode  
 Code for 8mm glass : GU8L.SS  
 Code for 10mm glass: GU10L.SS
- 
 Electropolished anode  
 Code for 8mm glass: GU8L.P  
 Code for 10mm glass: GU10L.P
- 
 Matte black anode  
 Code for 8mm glass: GU8L.B  
 Code for 10mm glass: GU10L.B

## HIGH U-PROFILE



- 
 Brushed Nickel effect anode  
 Code for 8mm glass : GU8H.SS  
 Code for 10mm glass: GU10H.SS
- 
 Electropolished anode  
 Code for 8mm glass: GU8H.P  
 Code for 10mm glass: GU10H.P
- 
 Matte black anode  
 Code for 8mm glass: GU8H.B  
 Code for 10mm glass: GU10H.B

### MEASUREMENTS

For 8mm glass

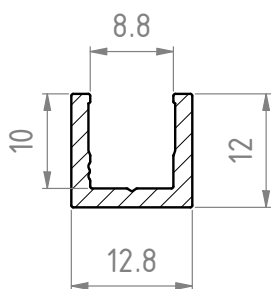

For 10mm glass

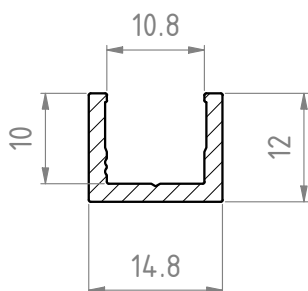

### MEASUREMENTS

For 8mm glass

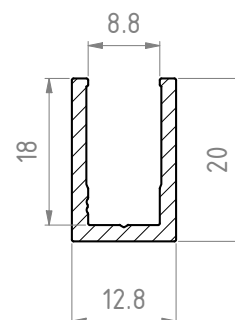

For 10mm glass

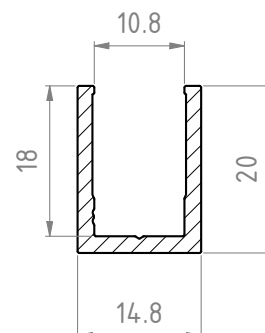

\*Material: aluminium with an anodized surface



**R•FIX**  
GLASS FIXINGS PRODUCER

14 Kurna Street, Kiili 75401,  
Harju County, Estonia  
Phone: +372 5629 1232  
E-mail: [info@rfix.eu](mailto:info@rfix.eu)  
[rfix.eu](http://rfix.eu)