



**NordX**  
**SAUNA- JA DUŠISARI**



---

# SISUKORD

5	ETTEVÖTTEST
8	PINNAKATTED JA VÄRVITOONID
9	NordX HINGEDE PINNAVIIMISTLUSED
10	NordX DUŠIHINGED
12	HINGED
14	DUŠISEINA KLAMBRID
18	KLAASUKSE NUPUD
20	KLAASI TUGILATT
26	KLAASIMISPROFIILID

# NordX SAUNA- JA DUŠISARI

---

# ETTEVÖTTEST

R-FIX on 2010. aastal asutatud arhitektuursete klaasikinnituste tootja.

Aitame arhitektidel ja ehitajatel luua turvalisi klaasipirdeid, -varikatuseid, -fassaade ja muid vastutusrikkaid klaaskonstruksioone.

NordX sauna- ja dušitoodete sarjaga oleme ühendanud oma turvaliste klaasikinnituste tootmise kogemuse ajatu disainiga.

Kuigi puhtad vormid ja kaunid pinnakatted on pilkupüüdvad, on NordX toodete südameks siiski läbimõeldud funktsionaalsus.

Tere tulemast NordXi maailma!





---

# PINNAKATTED JA VÄRVITOONID



Harjatud must  
Kood: BB



Antiikmessing  
Kood: AQ



Harjatud nikkel  
Kood: BN



Harjatud messing  
Kood: G



Harjatud pronks  
Kood: BZ

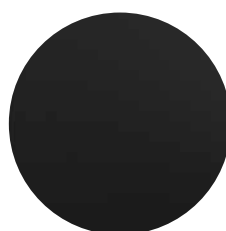

Matt must  
Kood: B



Poleeritud kroom  
Kood: P

\* Jätame endale õiguse lisada või eemaldada pinnakatteid tootevalikust

\*\* Kõik pinnakatted ei ole kõikide tarvikute jaoks saadaval

# NordX HINGEDE PINNAVIIMISTLUSED

Kas teie vannituba on kujundatud naturaalses, minimalistlikus või luksuslikus stiilis? Kas otsite retrohõngulist pronksjat aktsenti või eelistate klassikalist läikivat kroomi? NordXi sari pakub suurepäraseid pinnaviimistluste valikut.



Harjatud must



Antiikmessing



Harjatud nikkel



Harjatud messing



Harjatud pronks

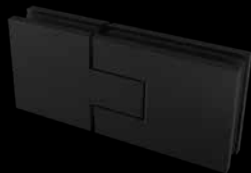

Matt must



Poleeritud kroom

\* Jätame endale õiguse lisada või eemaldada pinnakatteid tootevalikust

---

# NordX DUŠIHINGED

NordX dušihinged ühendavad ajatu disaini toimiva funktsionaalsusega ning jäävad vannitoas pea märkamatuks. Hinged on disainitud spetsiaalselt duši- ja saunauste jaoks ning tootevalikus on lisaks mitmeid nendega kokku sobivaid vannitoa klaasimise tarvikuid. NordX hinged sobivad kasutamiseks 6-10 mm paksuse karastatud klaasiga.

---

## REGULEERITAV NULLASEND

2 mm kuuskantvõtmega saab ukse nullasendit lihtsasti reguleerida ja fikseerida.



---

## PEIDETUD KINNITUSKRUVID

Kui kruvid on kinni keeratud, asetuvad katted klõpsuga oma kohale, andes hingele viimase lihvi.



---

## KUUMAKINDLAD TIHENDID

Klaasitihendid on kuumakindlad kuni temperatuurini 150 °C.

---

## KATSETATUD 100 000 TÖÖTSÜKLIGA

NordXi hinged on läbinud tsüklitesti, et tagada nende pikk kasutusiga.





# HINGED

## NordX 1

Materjal: messing  
Kandevõime: 50 kg paari kohta  
Isesulguv 20° nullasendist  
Tellimisel võimalik saada ka teisi värvi toone

- |  |  |
|--|--|
|  Harjatud nikkel<br>Kood: SH.NORD1.BN |  Poleeritud kroom<br>Kood: SH.NORD1.P |
|  Harjatud messing<br>Kood: SH.NORD1.G |  Matt must<br>Kood: SH.NORD1.B        |
|  Harjatud must<br>Kood: SH.NORD1.BB   |  Harjatud pronks<br>Kood: SH.NORD1.BZ |
|  Antiikmessing<br>Kood: SH.NORD1.AQ   |  |



## MÕÖTMED

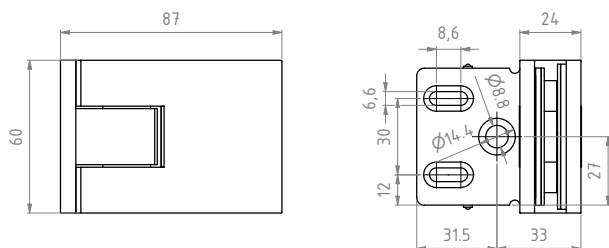

## KLAASI PAKSUS JA TIHENDID

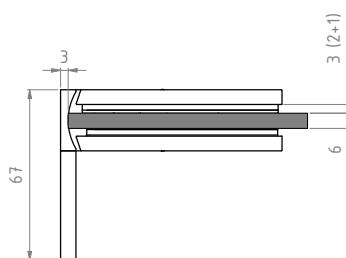

## KLAASI VÄLJALÕIGE

Seina ja klaasi vahe 3 mm

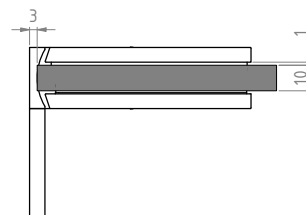
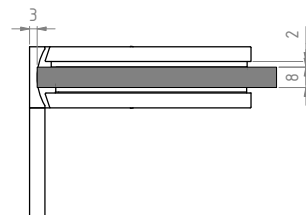
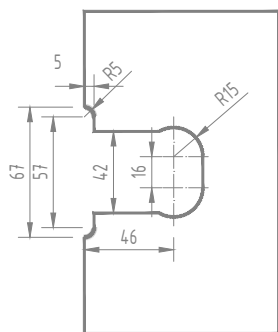

\* Saadaval ka DWG-joonised

## NordX 2

Materjal: messing  
Kandevõime: 50 kg paari kohta  
Ilesulguv 20° nullasendist  
Tellimisel võimalik saada ka teisi värvitoone

- |  |  |
|--|--|
|  Harjatud nikkel<br>Kood: SH.NORD2.BN |  Poleeritud kroom<br>Kood: SH.NORD2.P |
|  Harjatud messing<br>Kood: SH.NORD2.G |  Matt must<br>Kood: SH.NORD2.B        |
|  Harjatud must<br>Kood: SH.NORD2.BB   |  Harjatud pronks<br>Kood: SH.NORD2.BZ |
|  Antiikmessing<br>Kood: SH.NORD2.AQ   |  |



### MÕÖTMED

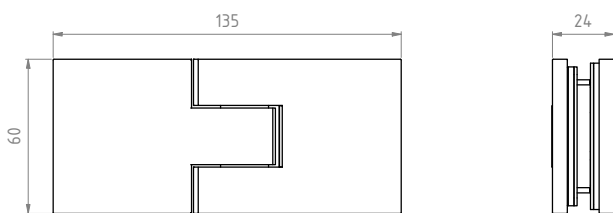

### KLAASI PAKSUS JA TIHENDID

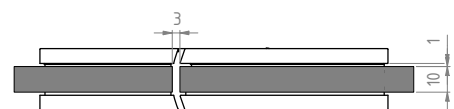
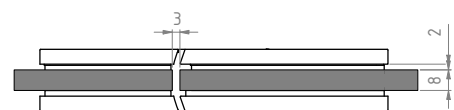
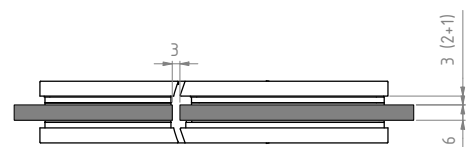

### KLAASI VÄLJALÕIGE

Klaaside vahe 3 mm

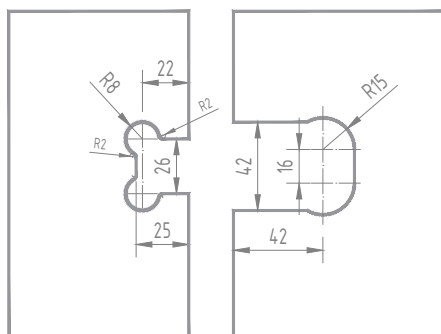





\* Saadaval ka DWG-joonised

# DUŠISEINA KLAMBRID

## SEIN-KLAAS KLAMBER

Peidetud kinnituskruvid  
Kuumakindlad tihendid  
Vajab Ø14 mm ava klaasis  
Tellimisel võimalik saada ka teisi värvitoone

- |   |   |
|---|---|
|  Harjatud nikkel<br>Kood: SH.C1.BN |  Poleeritud kroom<br>Kood: SH.C1.P |
|  Harjatud messing<br>Kood: SH.C1.G |  Matt must<br>Kood: SH.C1.B        |
|  Harjatud must<br>Kood: SH.C1.BB   |  Harjatud pronks<br>Kood: SH.C1.BZ |
|  Antiikmessing<br>Kood: SH.C1.AQ   |   |



### MÕÖTMED

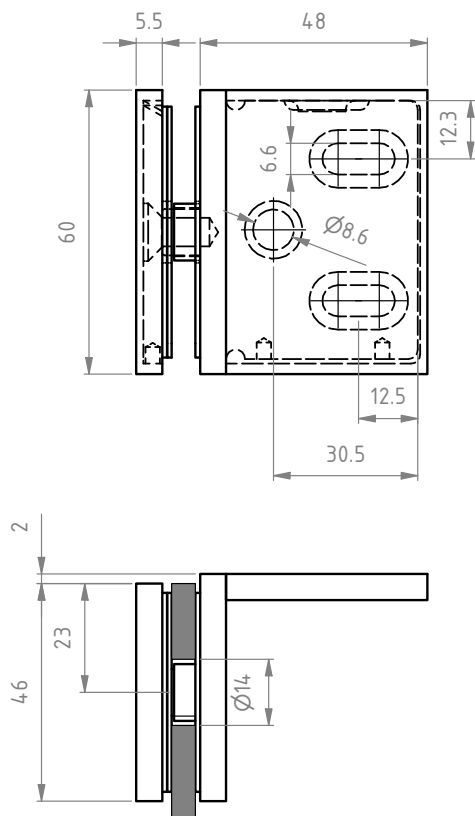

### KLAASI PAKSUS JA TIHENDID

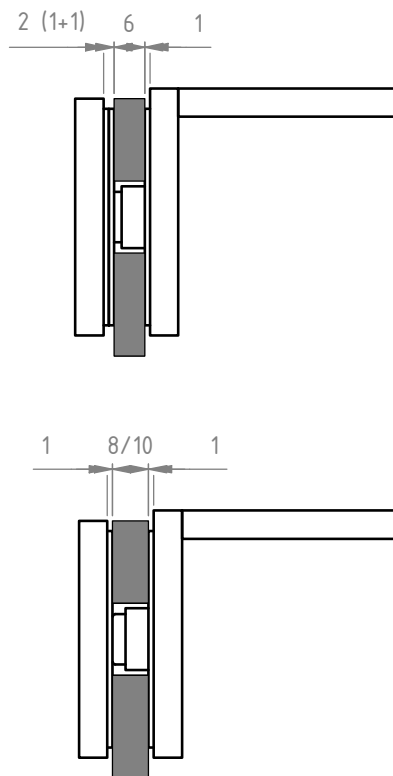

\* Saadaval ka DWG-joonised

## KLAAS-KLAAS KLAMBER 180°

Peidetud kinnituskruvid  
Kuumakindlad tihendid  
Vajab Ø14 mm avasid klaasides  
Tellimisel võimalik saada ka teisi värvitoone

- |   |   |
|---|---|
|  Harjatud nikkel<br>Kood: SH.C2.BN |  Poleeritud kroom<br>Kood: SH.C2.P |
|  Harjatud messing<br>Kood: SH.C2.G |  Matt must<br>Kood: SH.C2.B        |
|  Harjatud must<br>Kood: SH.C2.BB   |  Harjatud pronks<br>Kood: SH.C2.BZ |
|  Antiikmessing<br>Kood: SH.C2.AQ   |   |



### MÕÖTMED

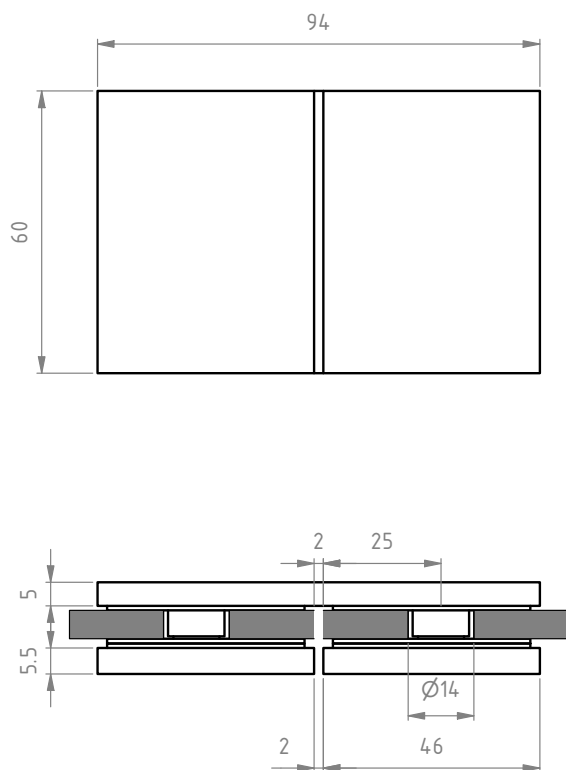

### KLAASI PAKSUS JA TIHENDID

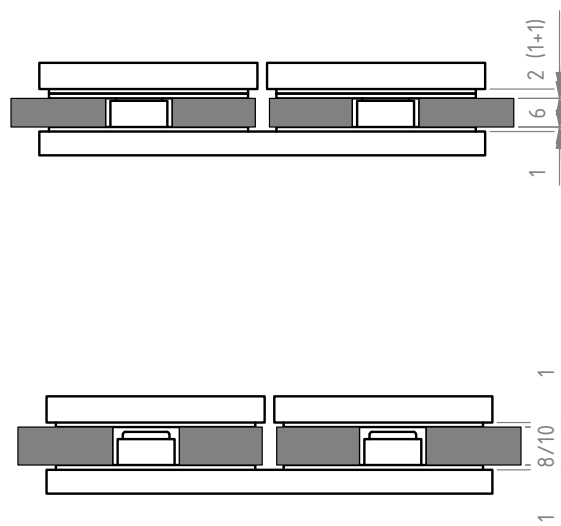

\* Saadaval ka DWG-joonised

# DUŠISEINA KLAMBRID

## KLAAS-KLAAS KLAMBER 90°

Peidetud kinnituskruvid  
Kuumakindlad tihendid  
Vajab Ø14 mm avasid klaasides  
Tellimisel võimalik saada ka teisi värvitoone

- |   |   |
|---|---|
|  Harjatud nikkel<br>Kood: SH.C3.BN |  Poleeritud kroom<br>Kood: SH.C3.P |
|  Harjatud messing<br>Kood: SH.C3.G |  Matt must<br>Kood: SH.C3.B        |
|  Harjatud must<br>Kood: SH.C3.BB   |  Harjatud pronks<br>Kood: SH.C3.BZ |
|  Antiikmessing<br>Kood: SH.C3.AQ   |   |



### MÕÖTMED

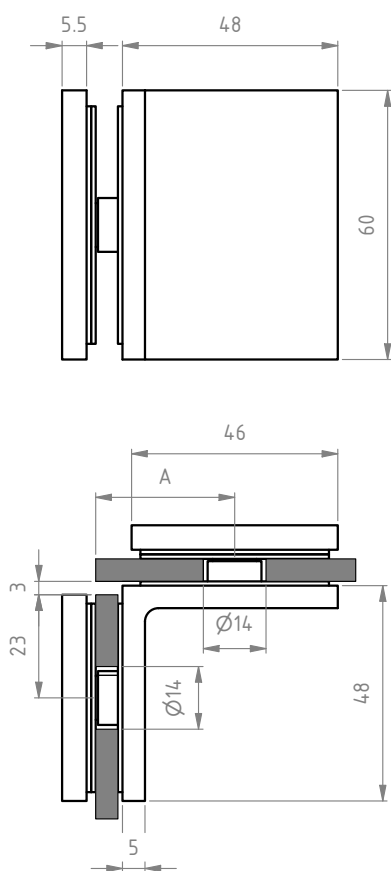

### KLAASI PAKSUS JA TIHENDID

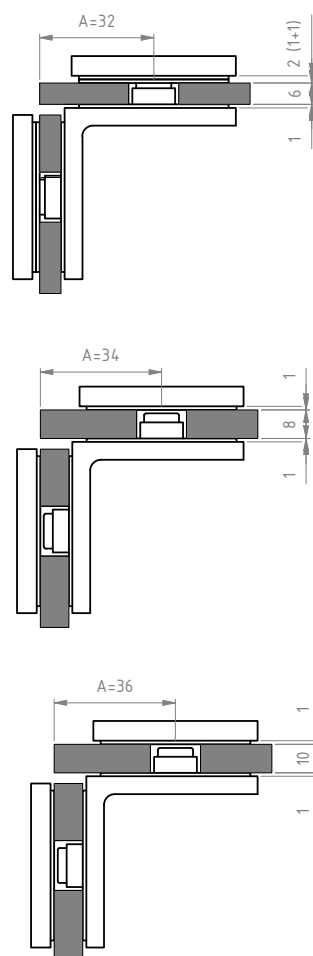

\* Saadaval ka DWG-joonised









# KLAASUKSE NUPUD







## ÜMAR DUŠIUKSE NUPP



## ÜMAR SAUNA-/ DUŠIUKSE NUPP



- |   |  |
|---|--|
|  Harjatud nikkel<br>Kood: SH.K1.BN  |  Poleeritud kroom<br>Kood: SH.K1.P |
|  Harjatud messing<br>Kood: SH.K1.G |  Harjatud must<br>Kood: SH.K1.BB  |
|  Harjatud pronks<br>Kood: SH.K1.BZ |  Antiikmessing<br>Kood: SH.K1.AQ  |

- |  |   |
|--|---|
|  Harjatud nikkel<br>Kood: SH.K1W.BN  |  Poleeritud kroom<br>Kood: SH.K1W.P |
|  Harjatud messing<br>Kood: SH.K1W.G |  Harjatud must<br>Kood: SH.K1W.BB  |
|  Harjatud pronks<br>Kood: SH.K1W.BZ |  Antiikmessing<br>Kood: SH.K1W.AQ  |

### MÕÕTMED

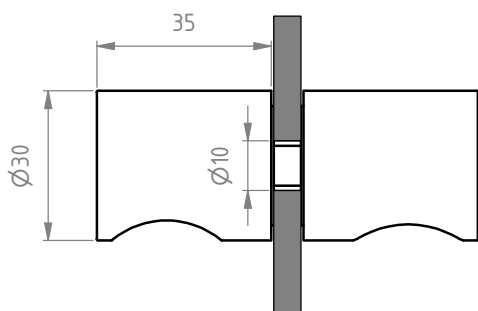



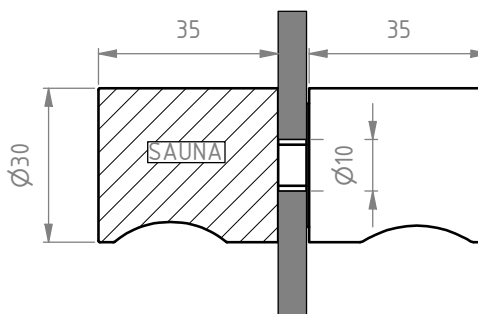



### MÕÕTMED



\* Materjal: messing. Saunapoolne nupp on valmistatud naturaalsest puidust ja see tuleks enne kasutamist pinnakattega töödelda.







## NELINURKNE DUŠIUKSE NUPP



- |   |   |
|---|---|
|  Harjatud nikkel<br>Kood: SH.K2.BN |  Poleeritud kroom<br>Kood: SH.K2.P |
|  Harjatud messing<br>Kood: SH.K2.G |  Harjatud must<br>Kood: SH.K2.BB   |
|  Harjatud pronks<br>Kood: SH.K2.BZ |  Antiikmessing<br>Kood: SH.K2.AQ   |

## NELINURKNE SAUNA-/ DUŠIUKSE NUPP



- |  |  |
|--|--|
|  Harjatud nikkel<br>SH.K2W.BN       |  Poleeritud kroom<br>Kood: SH.K2W.P |
|  Harjatud messing<br>Kood: SH.K2W.G |  Harjatud must<br>Kood: SH.K2W.BB   |
|  Harjatud pronks<br>Kood: SH.K2W.BZ |  Antiikmessing<br>Kood: SH.K2W.AQ   |

### MÕÕTMED

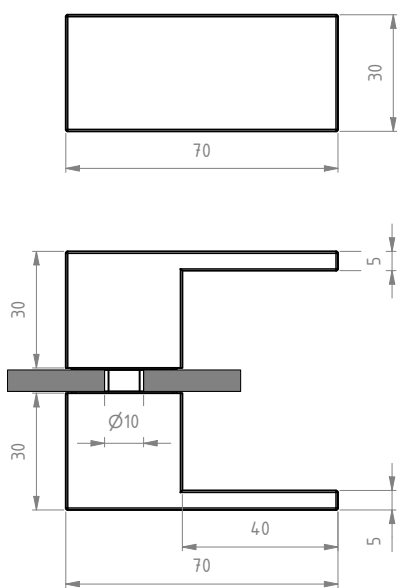

### MÕÕTMED

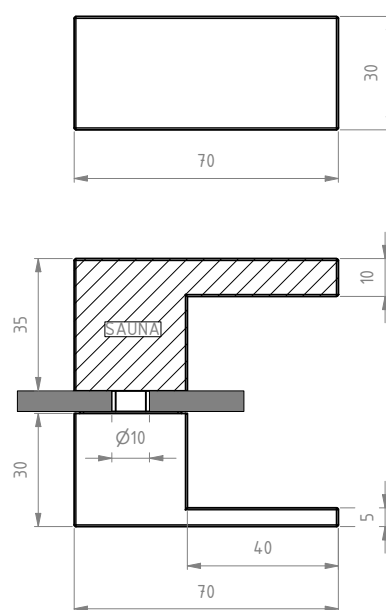

\* Materjal: messing. Saunapoolne nupp on valmistatud naturaalsest puidust ja see tuleks enne kasutamist pinnakattega töödelda.

---

# KLAASI TUGILATT

Tugilatt on suurepärase viisi dušiklaaside kinnitamiseks ülaservast. Kuna latt koosneb moodulitest, sobib see mitmesuguste dušiseinte kinnitamiseks - tuleb vaid valida õiged komponendid.

## KLASSIKALINE DUŠINURK



## LAIENDATUD DUŠINURK



## TÄISKABIIN



---

**KLASSIKALINE  
DUŠINIŠŠ**



**LAIENDATUD  
DUŠINIŠŠ**









**AVATUD  
DUŠISEIN**



# KLAASI TUGILATT







## REGULEERITAV KLAASIÜHENDUS



- |  |   |
|--|---|
|  Harjatud nikkel<br>Kood: SH.TC1.BN  |  Poleeritud kroom<br>Kood: SH.TC1.P |
|  Harjatud messing<br>Kood: SH.TC1.G |  Harjatud must<br>Kood: SH.TC1.BB  |
|  Harjatud pronks<br>Kood: SH.TC1.BZ |  Antiikmessing<br>Kood: SH.TC1.AQ  |

## REGULEERITAV SEINAÜHENDUS



- |  |   |
|--|---|
|  Harjatud nikkel<br>Kood: SH.TC2.BN  |  Poleeritud kroom<br>Kood: SH.TC2.P |
|  Harjatud messing<br>Kood: SH.TC2.G |  Harjatud must<br>Kood: SH.TC2.BB  |
|  Harjatud pronks<br>Kood: SH.TC2.BZ |  Antiikmessing<br>Kood: SH.TC2.AQ  |

### MÕÖTMED

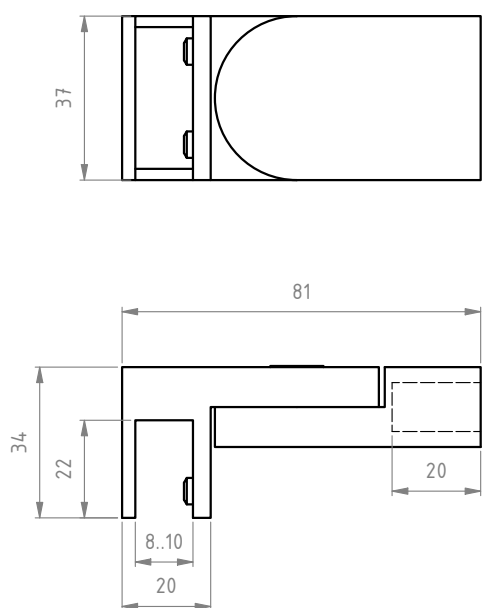



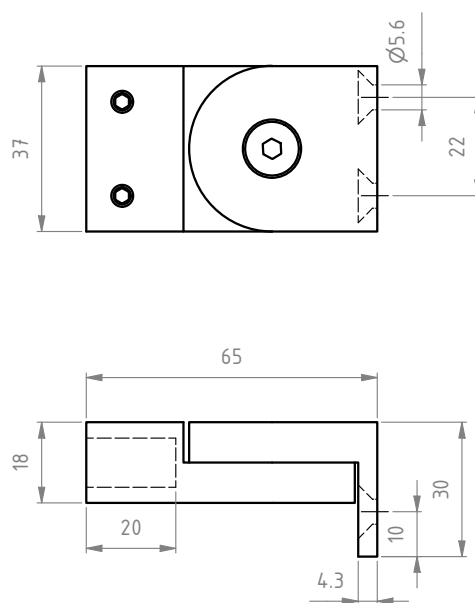



### MÕÖTMED



## LIHTNE SEINAÜHENDUS



- |  |   |
|--|---|
|  Harjatud nikkel<br>Kood: SH.TC3.BN  |  Poleeritud kroom<br>Kood: SH.TC3.P |
|  Harjatud messing<br>Kood: SH.TC3.G |  Harjatud must<br>Kood: SH.TC3.BB  |
|  Harjatud pronks<br>Kood: SH.TC3.BZ |  Antiikmessing<br>Kood: SH.TC3.AQ  |

## RISTLIITEGA ÜHENDUS



- |  |   |
|--|---|
|  Harjatud nikkel<br>Kood: SH.TC4.BN  |  Poleeritud kroom<br>Kood: SH.TC4.P |
|  Harjatud messing<br>Kood: SH.TC4.G |  Harjatud must<br>Kood: SH.TC4.BB  |
|  Harjatud pronks<br>Kood: SH.TC4.BZ |  Antiikmessing<br>Kood: SH.TC4.AQ  |

### MÕÕTMED

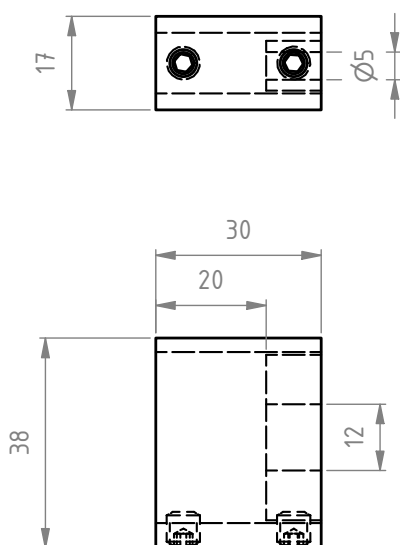

### MÕÕTMED

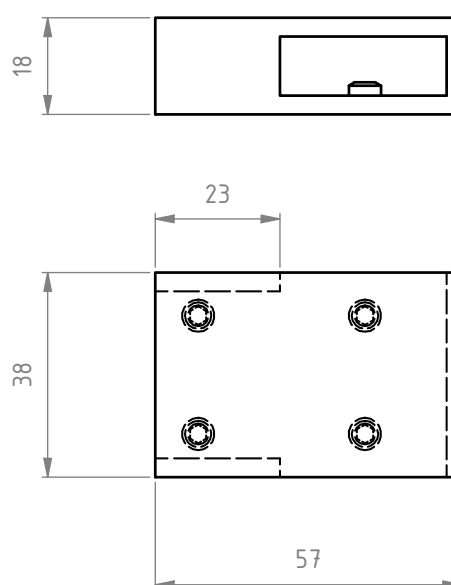

# KLAASI TUGILATT

**TORU 10 × 30,  
PIKKUS 1 M**



● Harjatud nikkel  
Kood: SH.Tx1M.BN

● Harjatud messing  
Kood: SH.Tx1M.G

● Harjatud pronks  
Kood: SH.Tx1M.BZ

● Poleeritud kroom  
Kood: SH.Tx1M.P

● Harjatud must  
Kood: SH.Tx1M.BB

● Antiikmessing  
Kood: SH.Tx1M.AQ

**TORU 10 × 30,  
PIKKUS 2 M**



● Harjatud nikkel  
Kood: SH.Tx2M.BN

● Harjatud messing  
Kood: SH.Tx2M.G

● Harjatud pronks  
Kood: SH.Tx2M.BZ

● Poleeritud kroom  
Kood: SH.Tx2M.P

● Harjatud must  
Kood: SH.Tx2M.BB

● Antiikmessing  
Kood: SH.Tx2M.AQ

## MÕÕTMED

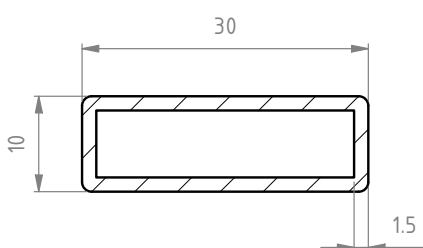

## MÕÕTMED

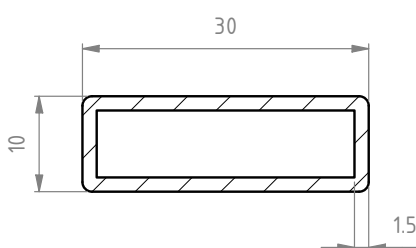



# KLAASIMISPROFIILID

## MADAL U-PROFIIL



- Anodeeritud, harjatud nikli efekt  
Kood 8 mm klaasile: GU8L.SS  
Kood 10 mm klaasile: GU10L.SS
- Haljas anodeeritud  
Kood 8 mm klaasile: GU8L.P  
Kood 10 mm klaasile: GU10L.P
- Anodeeritud matt must  
Kood 8 mm klaasile: GU8L.B  
Kood 10 mm klaasile: GU10L.B
- Harjatud messingu efekt  
Kood 8 mm klaasile: GU8L.G  
Kood 10 mm klaasile: GU10L.G
- Harjatud pronksi efekt  
Kood 8 mm klaasile: GU8L.BZ  
Kood 10 mm klaasile: GU10L.BZ

## KÕRGE U-PROFIIL



- Anodeeritud, harjatud nikli efekt  
Kood 8 mm klaasile: GU8H.SS  
Kood 10 mm klaasile: GU10H.SS
- Haljas anodeeritud  
Kood 8 mm klaasile: GU8H.P  
Kood 10 mm klaasile: GU10H.P
- Anodeeritud matt must  
Kood 8 mm klaasile: GU8H.B  
Kood 10 mm klaasile: GU10H.B
- Harjatud messingu efekt  
Kood 8 mm klaasile: GU8H.G  
Kood 10 mm klaasile: GU10H.G
- Harjatud pronksi efekt  
Kood 8 mm klaasile: GU8H.BZ  
Kood 10 mm klaasile: GU10H.BZ

### MÕÕTMED

8 mm klaasile

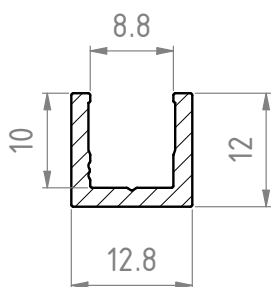

10 mm klaasile

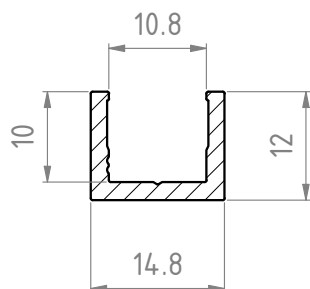

### MÕÕTMED

8 mm klaasile

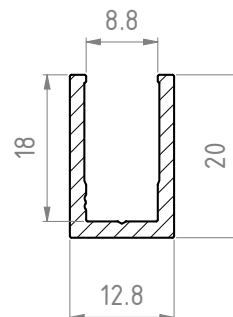

10 mm klaasile

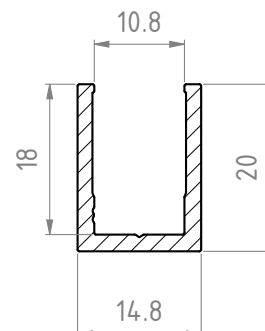

\* Materjal: alumiinium



**R•FIX**  
KLAASIKINNITUSTE TOOTJA

Suurvälja tee 1, Vaela 75413  
Harjumaa, Eesti  
Tel: +372 5685 5517  
E-post: [info@rfix.eu](mailto:info@rfix.eu)  
[rfix.eu](http://rfix.eu)